



Presentation in the deactivated condition:
Actuator removed

STS/K-System Benefits

- EU-Test certificate according to the directive 2006/42/EG, annex IX
- For safety applications up to PLe/Category 4 according to EN ISO 13849-1
- Modular and expandable system
- Rugged composite version of stainless steel and plastic design
- Wireless mechanical safeguarding
- Combines the benefits of safety switch, solenoid locking and key transfer in a single system
- Easy installation through comprehensive accessories
- Protection against lock-in
- Coding level low, medium, high according to DIN EN ISO 14119:2014-03

Features

- The unit is particularly suitable for applications with:
- Full body access (lock-in danger)
- Optional key removal
- Several secured entries
- Rugged ambient conditions
- This units are also available in stainless steel

Approvals and Markings



Function

Safety switch (type 2) for separating guards with electromagnetic solenoid locking.

Application

To secure separating guards such as safety gates and hoods in machine and plant engineering.

Design and Operation

Solenoid locking units prevent opening of separating guards and keep them closed as long as their is a risk of injury in the secured plant.

Attention!



Hazards must be ruled out before a key can be entered and the movable part of the guard can then be opened!

The STS/K solenoid locking unit is to be integrated into a system and connected with a control unit so that the hazardous machine can run only when the guard is locked and closed.

An access can only be opened and the actuator removed from actuator module B/K after a release signal was sent by the machine control to the ZRHBM/K solenoid locking unit. The movable part of the guard can be opened and closed as long as the release signal is still applied; the solenoid locking is not activated. The solenoid locking is activated again once no more release signal is applied and the guard is closed. The machine can now be restarted.

Actuator and magnet position are monitored by separate contacts. This makes this solenoid locking unit especially suitable for the setup mode of a machine.

ZRHBM/K is usually used in the system in connection with additional STS/K units and SAFEMASTER products (e.g. release by speed monitor UH 5947, standstill monitor LH 5946 or speed/standstill monitor BH 5932).

Circuit Diagrams

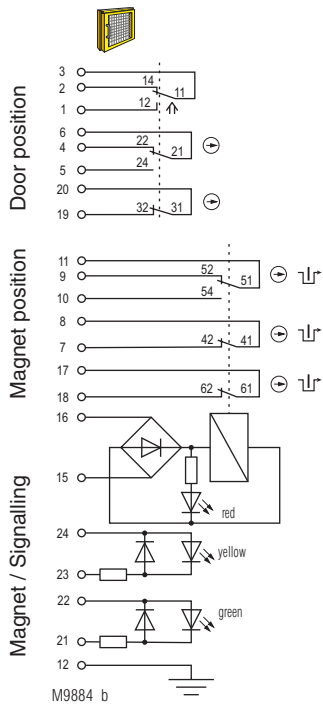

Fig. 1:
Solenoid locking activated:
Magnet locked,
Actuator inserted,
Door closed

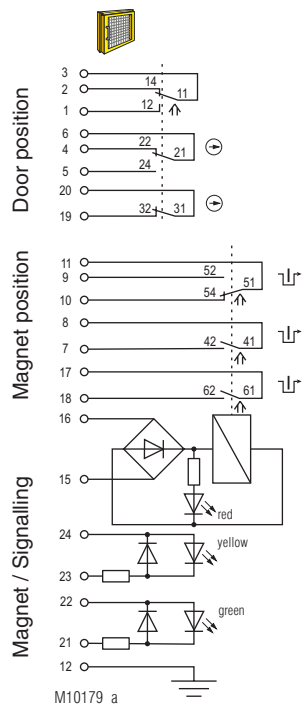

Fig. 2:
Solenoid locking deactivated:
Magnet released,
Actuator inserted,
Door closed

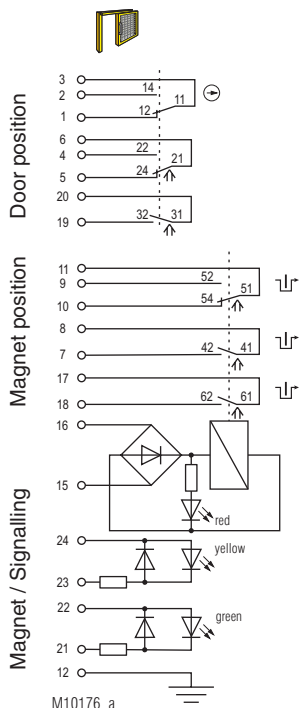

Fig. 3:
Solenoid locking deactivated:
Magnet released,
Actuator removed,
Door open

		Fig. 1	Fig. 2	Fig. 3
Door contacts	3	2	1	1
	6	4	3	3
	19	20	19	20
Magnet contact	11	9	11	9
	17	18	17	18
	7	8	7	8
	15	16	15	16
Control signal Magnet	15	16	15	16

■ closed
□ open

The state shown in **Figure 3** does not depend on the control signal of the magnet.
If the control signal is applied and the key inserted the solenoid locking changes to the state of **Figure 2**.
If no signal is applied and the key inserted the solenoid locking changes to the state of **Figure 1**

Technical Data

Enclosure:	PA + GF
Internal parts and inserting slots:	Stainless steel V4A / AISI 316 / AISI 630
Degree of protection:	IP 65
Temperature range standby current principle:	- 25 °C to + 38 °C
Temperature range load current principle:	- 25 °C to + 38 °C
Storage temperature:	- 25 °C to + 60 °C
Mechanical principle:	Rotating axis with redundant actuator
Connection method:	Cage clamp terminals
min. connection cross-section:	0.25 mm ²
max. connection cross-section:	0.75 mm ²
Cable entry:	1 x M20 x 1.5
B10 ₁₀ :	2 x 10 ⁶ switching cycles
Electrical service life:	5 x 10 ⁶ switching cycles
Locking force:	min. 2000 N
Shearing force:	depending on actuator
Solenoid locking principle:	Standby current, failure locking-proof
Magnetic principle:	Standby current or load current
min. operating speed:	100 mm/s
max. operating speed:	250 mm/s
max. switching frequency:	360/h
Operating mode:	100% ED
Nominal voltage U _N :	AC/DC 24 V
Nominal voltage range:	0.85 ... 1.1 U _N (see solenoid derating graph)
Power consumption:	6 W
Rated impulse voltage:	0.8 kV
Rated insulation voltage:	≤ 50 V
Overvoltage category:	III
Pollution degree:	2
Max. operating current:	
Standby current principle:	2 A
Load current principle:	1 A
Contacts:	
Door position:	1 NC contact, 2 antivalent changeover contacts
Magnet position:	2 NC contacts + 1 changeover contact
Switching principle:	Changeover contact with forced-opening snap-action switch
Utilization category of switching elements to AC 15:	1 A
to DC 13:	0.5 A
Contact material:	Ag / AgSnO ₂
Short circuit strength, max. fusing:	2 A gG
Rated conditional short circuit current:	1000 A
Indicator:	LED red/green, separate selection possible
Test principles:	EN ISO 13849-1:2008 DIN EN ISO 14119:2014-03 EN 60947-5-1:2005 GS-ET-15:02.2011 GS-ET-19:02-2011 GS-ET-31:02-2010
Intended use:	up to max. cat. 4, PL e according to EN ISO 13849-1 according to DIN EN 50041
Mounting:	IEC EN 60947-5-1 Appendix K
Contact elements:	
Additional requirement for cat. 4 structure (as single unit):	Add 2nd actuator module Type ZRHBBM/K
Diagnostic coverage (DC), (mechanical):	
Logic and output	
ZRHBM/K:	cat. 2 60 % cat. 3 90 % cat. 4 90 %
ZRHBBM/K:	90 % 90 % 99 %
Protection against faults of common cause:	see table in STS design guide
Repair and replacement:	by manufacturer only
Test intervals:	
for PL a to d:	min. once a year
for PL e:	min. once a month

Technical Data

ATTENTION !



To avoid wrong usage (e.g. by overload, mounting position or usage in acid, alkaline or other hostile ambient conditions) the limitations of the product have to be observed. Please check in advance if your application requires the usage of the more robust stainless steel model of SAFE-MASTER STS. The requirements of the mounting and operating instruction must be fulfilled.

Solenoid derating graph

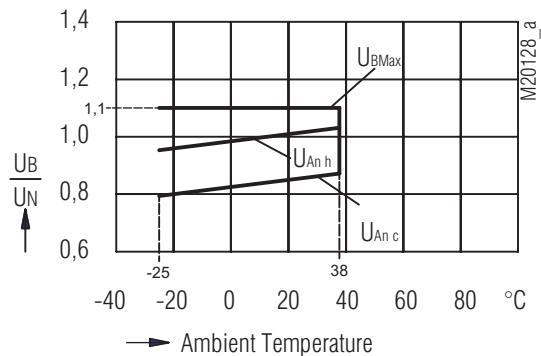

U_{BMax} maximum power supply dependent upon temperature
 $U_{An c}$ response voltage at coil temperature = ambient temperature
 $U_{An h}$ response voltage at preceding agitation at 1.1 x U_n

Ordering Example

STS- Z R H B M /K

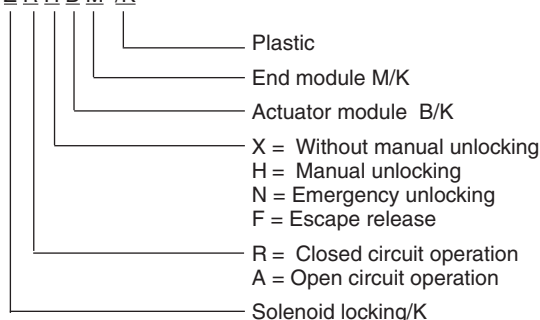

Versions of the solenoid locking module

ZRX/K Solenoid locking standby current principle

ZRH/K Solenoid locking standby principle with manual unlocking

ZRN/K Solenoid locking standby principle with emergency unlocking

Variants and Combination Options

Because of their modular design the basic units of the SAFEMASTER STS/K System can be combined and expanded according to customer requests. This allows for a variety of possible units and functions.

Overview of the basic units

Functions	Safety switches design type 2	Safety switches design type 2 with solenoid lock	Mechanical units design type 2	Mechanical units with electrical monitoring	Mechanical units with electrical release
Units with standard function	SXBM/K	ZRHBM/K	M10BM/K	RXK01M/K RX10BM/K	YRXKM/K YRXK01M/K
Units with mechanical lock and forced key extraction	SX01BM/K	ZRH01BM/K	M11BM/K	RXK11M/K RX11BM/K	YRX10BM/K YRX11BM/K
Units with optional key extraction	SXB01M/K	ZRHB01M/K	M10B01M/K	RX10B01M/K RX10K01M/K	YRX10B01M/K
Units without actuator	SX01M/K	ZRH01M/K	M12M/K	RX11M/K	YRX11M/K

For additional information refer to the data sheets of the individual modules and other basic units.

Data sheets

Switching module ZRX/K / ZRH/K / ZAX/K

Actuator module B/K

End module M/K



Take advantage of the advice of the E. DOLD & SÖHNE KG specialists regarding the choice of units and combination of a system.

Dimensional Drawing [mm]

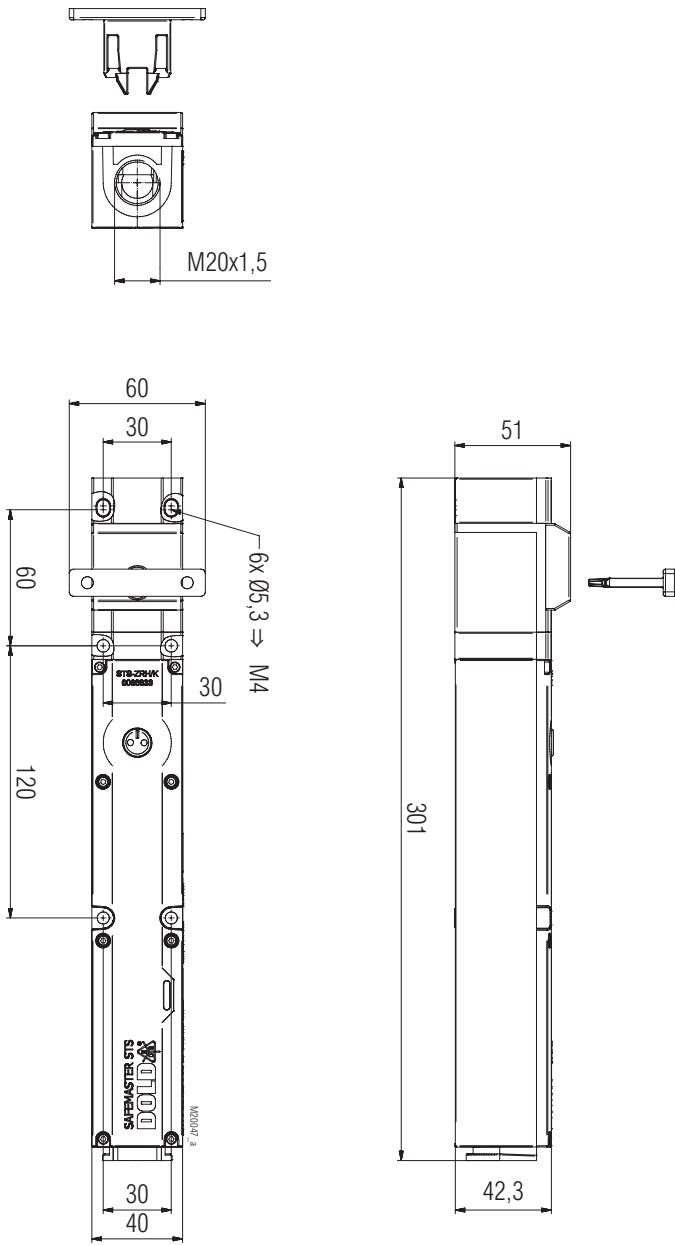

ZRHBM/K
Clearance tolerances $\pm 2\%$

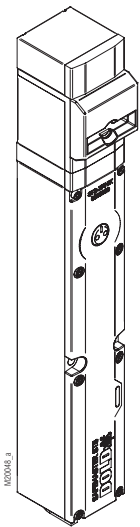

ZRHBM/K