



Presentation in the deactivated condition:
Key and actuator removed

STS/K-System Benefits

- EU-Test certificate according to the directive 2006/42/EG, annex IX
- For safety applications up to PLe/Category 4 according to EN ISO 13849-1
- Modular and expandable system
- Rugged composite version of stainless steel and plastic design
- Wireless mechanical safeguarding
- Combines the benefits of safety switch, solenoid locking and key transfer in a single system
- Easy installation through comprehensive accessories
- Protection against lock-in
- Coding level low, medium, high according to DIN EN ISO 14119:2014-03

Features

- The unit is particularly suitable for applications with:
 - Full body access (lock-in danger)
 - Optional key removal
 - Several secured entries
 - Rugged ambient conditions
- This units are also available in stainless steel

Approvals and Markings



Function

Safety switch with forced key removal and electromagnetic blocking of the key.

Application

To secure separating guards such as safety gates and hoods in machine and plant engineering.

Design and Operation

Solenoid locking units prevent opening of separating guards and keep them closed as long as their is a risk of injury in the secured plant.

Attention!



Hazards must be ruled out before a key can be inserted and the movable part of the guard can then be opened!

The STS/K solenoid locking unit is to be integrated into a system and connected with a control unit so that the hazardous machine can run only when the guard is locked and closed.

An access can only be opened after a release signal was sent by the machine control to the ZRH01BM/K solenoid locking unit. The actuator can only be removed from actuator module B/K and the access opened after removing the key from key module 01/K. Key operation is forced. Key entry ins blocked when the door is open. The key can be entered again after the access was closed again. Only after entering the key is the solenoid locking activated again and the machine can be restarted. Key and magnet position are monitored by separate contacts.

ZRH01BM/K is usually used in the system in connection with additional STS /K units and SAFEMASTER products (e.g. release by speed monitor UH 5947, standstill monitor LH 5946 or speed/standstill monitor BH 5932). The key with forced removal can be used as protection against lock-in.

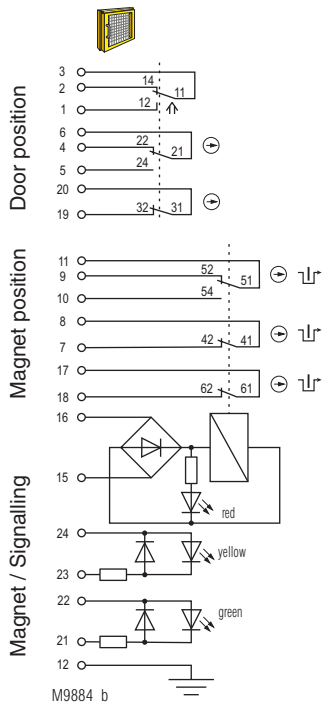

Fig. 1:
Solenoid locking activated:
Magnet locked, key
and actuator inserted,
Door closed

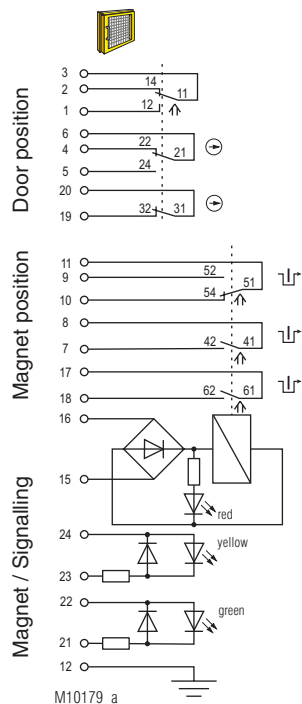

Fig. 2:
Solenoid locking deactivated:
Magnet released, key
and actuator inserted,
Door closed

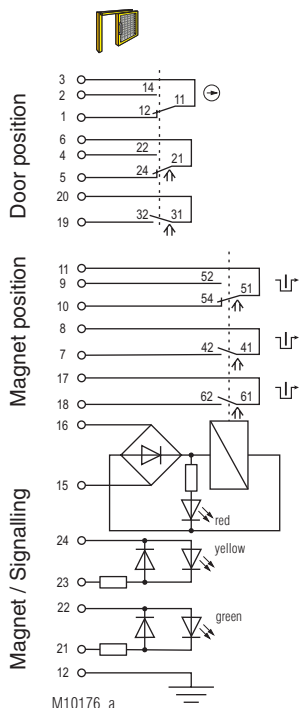

Fig. 3:
Solenoid locking deactivated:
Magnet released, key
and actuator removed,
Door open

		Fig. 1	Fig. 2	Fig. 3
Door contacts	3	2	1	1
	6	4	5	5
	19	20	19	19
Magnet contact	11	9	10	10
	7	8	7	7
	17	18	17	17
	15	16	15	15

■ closed
□ open

The state shown in **Figure 3** does not depend on the control signal of the magnet.
If the control signal is applied and the key inserted the solenoid locking changes to the state of **Figure 2**.
If no signal is applied and the key inserted the solenoid locking changes to the state of **Figure 1**

Enclosure: PA + GF
 Internal parts and inserting slots: Stainless steel V4A / AISI 316 / AISI 630
 Degree of protection: IP 65
 Temperature range standby current principle: - 25 °C to + 38 °C
 Temperature range load current principle: - 25 °C to + 38 °C
 Storage temperature: - 25 °C to + 60 °C
 Mechanical principle: Rotating axis with redundant actuator
 Connection method: Cage clamp terminals
 min. connection cross-section: 0.25 mm²
 max. connection cross-section: 0.75 mm²
 Cable entry: 1 x M20 x 1.5
 B10_g: 2 x 10⁶ switching cycles
 Electrical service life: 5 x 10⁶ switching cycles
 Locking force: min. 2000 N
 Shearing force: depending on actuator
 Solenoid locking principle: Standby current, failure locking-proof
 Magnetic principle: Standby current or load current
 min. operating speed: 100 mm/s
 max. operating speed: 250 mm/s
 max. switching frequency: 360/h
 Operating mode: 100% ED
 Nominal voltage U_N: AC/DC 24 V
 Nominal voltage range: 0.85 ... 1.1 U_N
 (see solenoid derating graph)

Power consumption: 6 W
 Rated impulse voltage: 0.8 kV
 Rated insulation voltage: ≤ 50 V
 Overvoltage category: III
 Pollution degree: 2
 Max. operating current: 2 A
 Standby current principle: 1 A
 Load current principle: 1 A
 Contacts: 1 NC contact, 2 antivalent changeover contacts
 Door position: 2 NC contacts + 1 changeover contact
 Switching principle: Changeover contact with forced-opening snap-action switch

Utilization category of switching elements to AC 15: 1 A
 to DC 13: 0.5 A
 Contact material: Ag / AgSnO₂
 Short circuit strength, max. fusing: 2 A gG
 Rated conditional short circuit current: 1000 A
 Indicator: LED red/green, separate selection possible
 Test principles: EN ISO 13849-1:2008
 DIN EN ISO 14119:2014-03
 EN 60947-5-1:2005
 GS-ET-15:02.2011
 GS-ET-19:02.2011
 GS-ET-31:02.2010

Intended use: up to max. cat. 4, PL e according to EN ISO 13849-1 according to DIN EN 50041
 Mounting: IEC EN 60947-5-1 Appendix K
 Contact elements: Add 2nd actuator module Type ZRH01BBM/K
 Additional requirement for cat. 4 structure (as single unit):
 Diagnostic coverage (DC), (mechanical):

Logic and output	cat. 2	cat. 3	cat. 4
ZRH01BM/K:	60 %	90 %	
ZRH01BBM/K:	90 %	90 %	99 %

Protection against faults of common cause: see table in STS design guide
 Repair and replacement: by manufacturer only
 Test intervals: min. once a year
 for PL a to d: min. once a month
 for PL e:

Technical Data

ATTENTION !



To avoid wrong usage (e.g. by overload, mounting position or usage in acid, alkaline or other hostile ambient conditions) the limitations of the product have to be observed. Please check in advance if your application requires the usage of the more robust stainless steel model of SAFE-MASTER STS. The requirements of the mounting and operating instruction must be fulfilled.

Solenoid derating graph

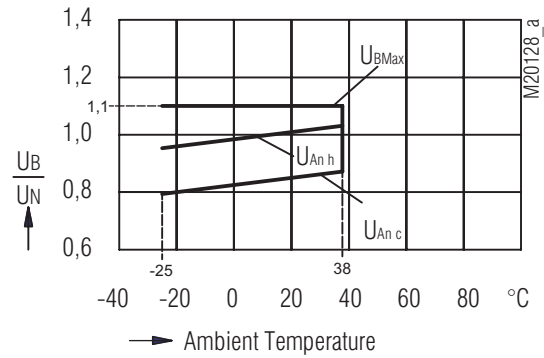

U_{BMax} maximum power supply dependent upon temperature
 $U_{An c}$ response voltage at coil temperature = ambient temperature
 $U_{An h}$ response voltage at preceding agitation at 1.1 x U_n

Ordering Example

STS- Z R H 01 B M /K

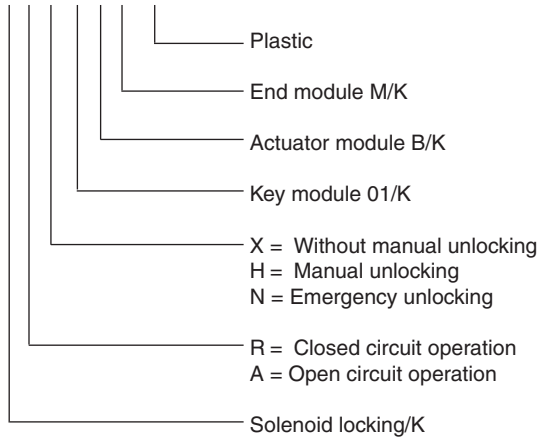

Variants and Combination Options

Because of their modular design the basic units of the SAFEMASTER STS/K System can be combined and expanded according to customer requests. This allows for a variety of possible units and functions.

Overview of the basic units

Functions	Safety switches design type 2	Safety switches design type 2 with solenoid lock	Mechanical units design type 2	Mechanical units with electrical monitoring	Mechanical units with electrical release
Units with standard function	SXBM/K	ZRHBM/K	M10BM/K	RXK01M/K RX10BM/K	YRXKM/K YRXK01M/K
Units with mechanical lock and forced key extraction	SX01BM/K	ZRH01BM/K	M11BM/K	RXK11M/K RX11BM/K	YRX10BM/K YRX11BM/K
Units with optional key extraction	SXB01M/K	ZRHB01M/K	M10B01M/K	RX10B01M/K RX10K01M/K	YRX10B01M/K
Units without actuator	SX01M/K	ZRH01M/K	M12M/K	RX11M/K	YRX11M/K

For additional information refer to the data sheets of the individual modules and other basic units.

Data sheets

Switching module ZRX/K / ZRH/K / ZAX/K
 Key module 01/K / 10/K
 Actuator module B/K
 End module M/K



Take advantage of the advice of the **E. DOLD & SÖHNE KG** specialists regarding the choice of units and combination of a system.

Dimensional Drawing [mm]

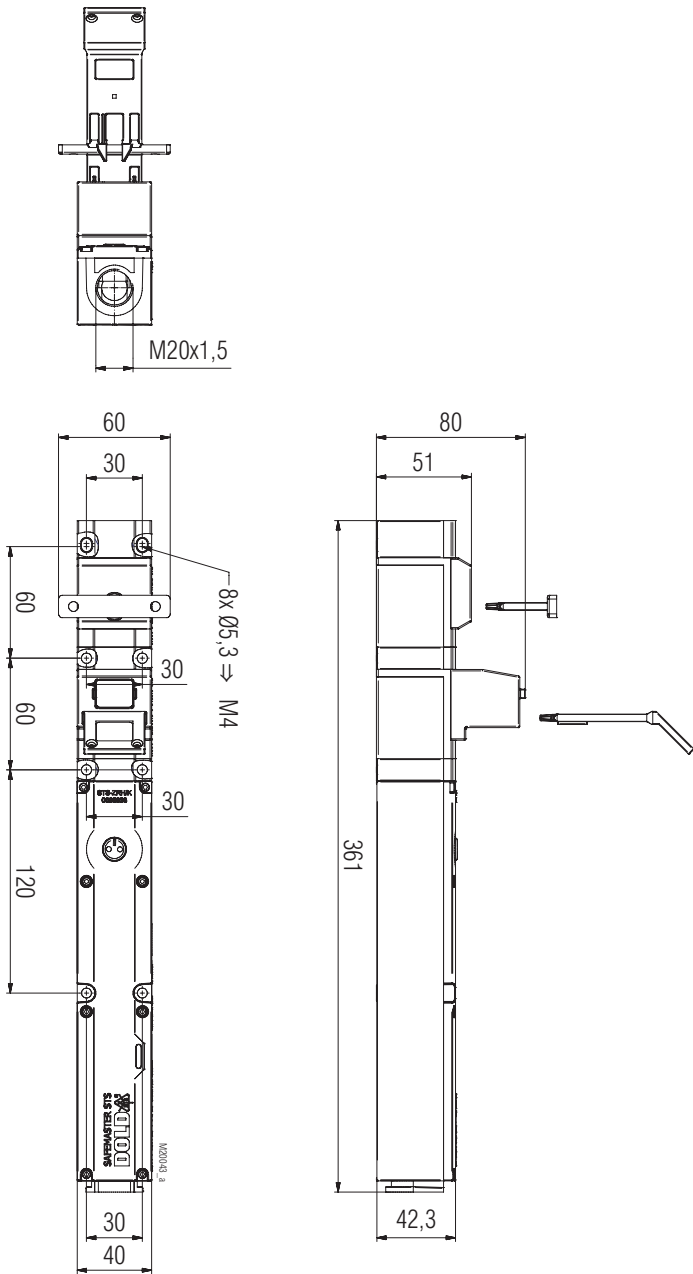

ZRH01BM/K
Clearance tolerances $\pm 2\%$

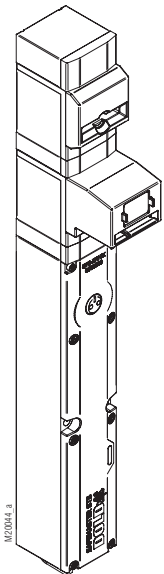

ZRH01BM/K