

**MINISTART
Softstarter
PF 9015**



0277914

Your Advantages

- For starting current limitation and soft start of asynchronous motors
- Only one small device 67.5 mm for softstart, motor protection, phase sequence, under- and overvoltage monitoring
- Soft start and minimized starting current
- Extended service life of AC - motors and mechanical drive system
- For motor currents up to 20 A (up to 40 A on request)
- Softstart, softstop 1 ... 20 s
- Energy saving by bridging of the semiconductors after softstart
- Symmetrical starting current

Features

- According to IEC/EN 60 947-4-2
- Suitable for IE3-motors
- 3-phase controlled with integrated bypass relays
- Phase sequence, under- and overvoltage monitoring
- Blocked motor monitoring in bypass mode
- Integrated motor protection to class 10 acc. to IEC/EN 60947-4-2
- Starting current limitation
- Thyristor monitoring
- Detection of missing load
- Automatic frequency detection of supply voltage
- Temperature monitoring of power semiconductors
- Kickstart function
- Width: 67,5 mm

Product Description

The PF 9015 of the MINISTART family is a robust electronic control device for softstart and softstop of 3-phase asynchronous motors with integrated monitoring functions. After softstart the semiconductors are bridged by relay contacts to reduce the power dissipation in the unit.

Function diagram

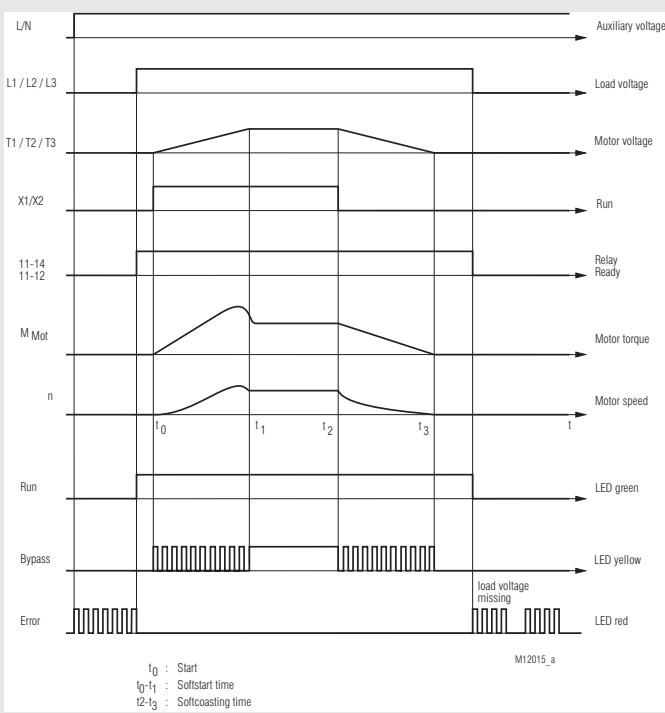

Approvals and Markings



Applications

- Pumps
- Fans and ventilation systems
- Conveyor systems and elevators
- Compressors
- Mills, crushers, presses
- ... and for all applications with ambitious start-up and deceleration

Function Notes

Variation of speed is not possible with this device.

Indication

The device status is indicated with different coloured LEDs and flash code

- LED - green Device ready
- LED - yellow On, when bridging relay active
Flashes, when softstart, softstop function active
- LED - red Flashes if error (see flash codes)

Block Diagram

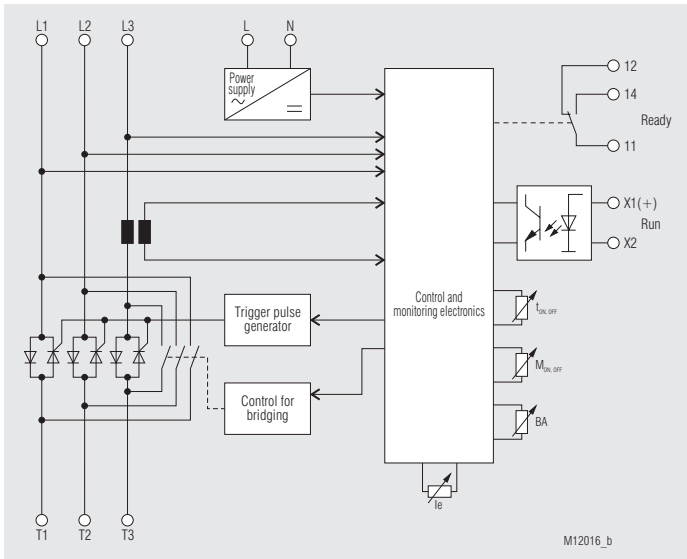

Terminal Connection

Terminal designation	Signal description
X1(+), X2	Start signal "Run"
11, 12, 14	Indicator relay "Ready"
L, N	auxiliary voltage
L1	Load voltage L1
L2	Load voltage L2
L3	Load voltage L3
T1	Motor voltage T1
T2	Motor voltage T2
T3	Motor voltage T3

Outputs

One output relay is available.
Contact 11/14 is closed and contact 11/12 open if no device fault is present

Auxiliary Supply

To monitor phase failure on all 3 phases an external auxiliary supply of AC 230 V is necessary.

Control Elements

Potentiometer

I_e :	Nominal current for overload protection and starting current limitation, blocking protection
t_{on} / t_{off} :	Ramp up / deceleration time
M_{on} / M_{off} :	Starting- / deceleration torque

Stepping potentiometer

BA Operating modes

0:	Standard
1:	Current limitation during start-up = $4 \times I_e$
2:	Kickstart 100 ms
3:	Kickstart 200 ms
4:	Kickstart 400 ms
5:	Kickstart 100 ms and current limitation
6:	Kickstart 200 ms and current limitation
7:	Kickstart 400 ms and current limitation
8:	Not used
9:	Not used



Note: The potentiometer setting is only read when connecting the power supply or on reset at failure mode.

Reset-button: Reset of failure mode after failure is removed and confirming potentiometer setting.

Device Description

Voltage monitoring

Under and overvoltage on the load voltage is monitored. If the voltage is out of range this will lead to a motor stop and failure indication on the unit.

Phase sequence monitoring

The phase sequence monitoring function monitors clockwise phase sequence of the 3-phase system. An anti-clockwise sequence forces the unit to failure mode.

Kickstart function

Using the rotary switch BA the kickstart function can be activated. At the begin of the softstart the motor voltage will be switched to 400 V for 100 ms or 200 ms or 400 ms. This creates an increased break off torque and allows starting of motors with high holding force at standstill. After that the softstart follows with the adjusted starting ramp.

Shortcircuited Thyristor

Before each softstart the power-semiconductors are tested for short circuit. A detected short circuit forces the unit to failure mode. For short circuit test the motor must be connected.

Motor not connected

Before each softstart it is tested that the motor is correctly connected to the unit. This test avoids that the motor starts on 2 phases and gets faulty. Wrong connection forces the unit to failure mode.

Overtemperature

The temperature of the semiconductors is measured by NTC sensor. Overtemperature forces the unit into failure mode.

Frequency detection

To achieve a correct function the actual frequency has to be known. The frequency is monitored after power on or reset. If the frequency is outside the limits $50\text{Hz} \pm 5\text{ Hz}$ or $60\text{ Hz} \pm 5\text{ Hz}$ the unit switches to failure mode.

Blocking protection

In Bypass mode a blocking of the motor is detected by current monitoring. If the current exceeds 5 times the nominal current of the motor, the unit recognizes motor blocking. The unit switches to failure mode.

Overload protection

The unit incorporates an electronic overload protection, which is realized by monitoring the current in one phase. Overload protection class 10 is a fix setting. The response current can be adjusted with a potentiometer by adjusting the motor rated current. When the I^2t value is overridden the unit switches into failure mode. The I^2t value is reset with the reset function.



Note: At loss of the auxiliary supply the actual I^2t -value is stored. At restart the I^2t -value is recalled and used for operation independent how long the motor was cooling down.

Limitation of starting current

By starting current limitation the peak current can be limited. The load on the supply network is lower. The time limit of the current is monitored and if the starting time exceeds the limit of 5 s a failure signal is indicated. The current limit is fixed to 2.5 times the motor nominal current.

Failure mode

If a device or function failure is detected, the unit goes into failure mode. The motor is disconnected and the indicating relay de-energises. Pressing the reset button exits the failure mode. Please make sure that when pressing the reset button, the start signal is disconnected to avoid unintentional starting.

Control Circuit Run

The control input X1(+), X2 works with a voltage of AC/DC 20 ... 300 V.



After reset or disconnecting the power supply the unit initiates a softstart, if voltage is connected to control input.

Fault Indication by Flashing Code

During normal operation failure messages may occur. The messages are indicated by a flashing sequence of the red LED0

Flashes *)	Fault	Possible cause	Troubleshooting
1 x fast	Motor voltage is missing	Defective fuse, faulty wiring	Check fuses and wiring
1	Device temperature to high	Duty cycle exceeded	Reduce operating time, use heat sink if possible
2	Mains frequency out of tolerance	Wrong frequency	Device is not suitable for actual frequency. Contact manufacturer
3	Phase sequence incorrect	Load voltage incorrect. Clockwise phase sequence is mandatory for correct function	Check wiring, change 2 phases
4	Undervoltage of load voltage	Undervoltage	Check load voltage, check fuses
5	Overload detected	Motor overloaded	Reduce operating time, Motor rough-running? Adjust nominal current
6	Motor blocked in Bypass-Mode	Motor stalled in operation	Check motor
7	Thyristor short-circuit	Faulty thyristor detected	Device has to be repaired
9	Motor connected incorrectly	One or more wires to the motor are interrupted	Check wiring to motor
10	Temperature sensor defective	Interruption or short circuit in temperature sensor of power semiconductors	Device has to be repaired
11	Overvoltage	Load overvoltage	Check load voltage, check fuses
12	Overcurrent at end of starting ramp	Blocked motor, heavy duty starting or ramp time to short	Increase ramp time, remove motor blocking, check motor on possible high friction

*) No.: Number of flash pulses in a series

Technical Data

Auxiliary supply:	AC 230 V ± 10%
Overvoltage protection:	Varistor AC 275 V
Ramp up / deceleration time:	1 ... 20 s
Starting / deceleration torque:	20 ... 70 % of rated motor torque
Kickstart voltage:	Full switched thyristors
Kickstart time:	100 ms, 200 ms, 400 ms
Consumption:	4 VA

Control Input Run X1(+), X2

Control voltage:	AC/DC 20 ... 300 V
Control input current:	0.2 mA ... 3.1 mA
Start up delay:	60 ms
Release delay:	320 ms

Indicator Output Ready 11, 12, 14

Contacts:	1 changeover contact
Switching capacity to AC 15	
NO contacts:	3 A / AC 230 V IEC/EN 60 947-5-1
NC contacts:	1 A / AC 230 V IEC/EN 60 947-5-1
Electriscical life to AC 15 bei 3 A, AC 230 V:	2 x 10 ⁵ switching cycles
Permissible switching frequency:	max. 1 800 switching cycles / h
Short circuit strength max. fuse rating:	4 A gG / gL IEC/EN 60 947-5-1
Mechanical life:	≥ 10 ⁸ switching cycles

Output / Load Circuit

Load circuit	
Nominal operating voltage L1-L3:	3 AC 200 ... 480 V
Making voltage:	3 AC 185 V
Undervoltage:	3 AC 175 V
Overvoltage:	3 AC 530 V
Peak reverse voltage:	1200 V
Overvoltage protection:	Varistor 510 V
Nominal frequency:	50 Hz ± 5 Hz oder 60 Hz ± 5Hz
Nominal operating current I_e:	20 A
Setting range I_e:	5 A ... 20 A
Rated motor power at 400 V:	7.5 kW
Surge current:	1050 A (tp = 10 ms)
Load limit integral:	5500 A ² s
Resolution current measurement:	0.1 A
Usage category:	20: AC-53b: 4 - 20: 100
Number of starts per hour:	20
Overload protection:	Klasse 10
Blocking protection, response value:	5 x I _e , for longer than 1 s in bypass mode
Current limiting:	4 x I _e ± 10% during ramp up
Short circuit detection	
Mode 1:	35 A gG / gL
Mode 2:	5500 A ² s

General Data

Temperature range operation:	0 ... + 50 °C
storage:	- 20 °C ... +75 °C
Relative air humidity:	< 95%, no condensation at 40°C
Altitude:	< 1.000 m

EMC

Clearance and Creepage distances

rated impulse voltage / pollution degree	
Overvoltage category:	III
Mains-/Motor voltage-heat sink:	6 kV / 2 IEC/EN 60 947-4-2
Mains-/Motor voltage - control voltage:	6 kV / 2 IEC/EN 60 947-4-2
Mains-/Motor voltage-indicator relay:	6 kV / 2 IEC/EN 60 947-4-2
Electrostatic discharge:	8 kV (air) IEC/EN 61 000-4-2
HF-irradiation	
80 MHz ... 1.0 GHz:	10 V / m IEC/EN 61 000-4-3
1.0 GHz ... 2.5 GHz:	10 V / m IEC/EN 61 000-4-3
2.5 GHz ... 2.7 GHz:	10 V / m IEC/EN 61 000-4-3
Fast transients:	2 kV IEC/EN 61 000-4-4

Technical Data

Surge voltage between wires for power supply:	1 kV	IEC/EN 61 000-4-5
between wire and ground:	2 kV	IEC/EN 61 000-4-5
HF-wire guided:	10 V	IEC/EN 61 000-4-6
Voltage dips:		IEC/EN 61 000-4-11
Voltage dips:		IEC/EN 61 000-4-11
Interference emission		
Wire guided:		IEC/EN 60 947-4-2
Radio irradiation:		IEC/EN 60 947-4-2
Harmonics in bypass mode:		IEC/EN 61 000-3-11

Degree of Protection

Enclosure:	IP 40	IEC/EN 60 529
Terminals:	IP 20	IEC/EN 60 529

Housing:

Vibration resistance

Climate resistance:

Wire connections

Load terminals:

Box terminals with self-lifting wire protection	
Captive M4 Pozidriv-terminal screws	
0,5 ... 16 mm ² solid	
0,5 ... 16 mm ² mit stranded wire with sleeve	
DIN 46228/1	
0,5 ... 16 mm ² stranded ferruled (isolated)	
DIN 46228/4	
21 - 6 AWG	

Insulation of wires or sleeve length:

Mounting torque:

Control terminals

12 mm - 13 mm	
2.5 Nm	
pluggable terminal blocks with cage clamp terminals	
0.2 - 2.5 mm ² solid	
0.2 - 2.5 mm ² ferruled	
0.2 - 2.5 mm ² stranded wire with sleeve	
DIN 46228/1	
0.2 - 2.5 mm ² stranded ferruled (isolated)	
26 - 12 AWG	

Insulation of wires or sleeve length:

Weight

8 mm	
with DIN rail mounting:	960 g

Dimensions

Width x height x depth:	67.5 mm x 122.4 mm x 122.1 mm
	with fixing plate
	with heat sink

Standard Type

PF 9015.11	3 AC 200 ... 480 V	50 Hz	U _H 230 V	20 A
Article number:			0068478	
• Load voltage:	3 AC 200 ... 480 V			
• Auxiliary voltage U _H :	AC 230 V			
• Nominal operating current I _e :	20 A			
• Setting range I _e :	5 A ... 20 A			
• Width:	67.5 mm			

Ordering Example

PF 9015 .11 3 AC 200 ... 480 V 50 Hz U_H 230 V 20 A

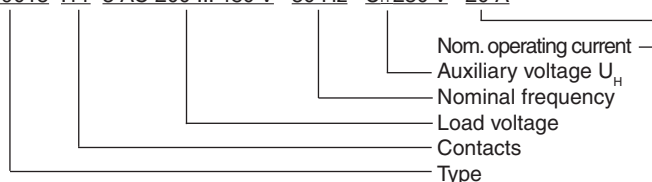

Characteristics

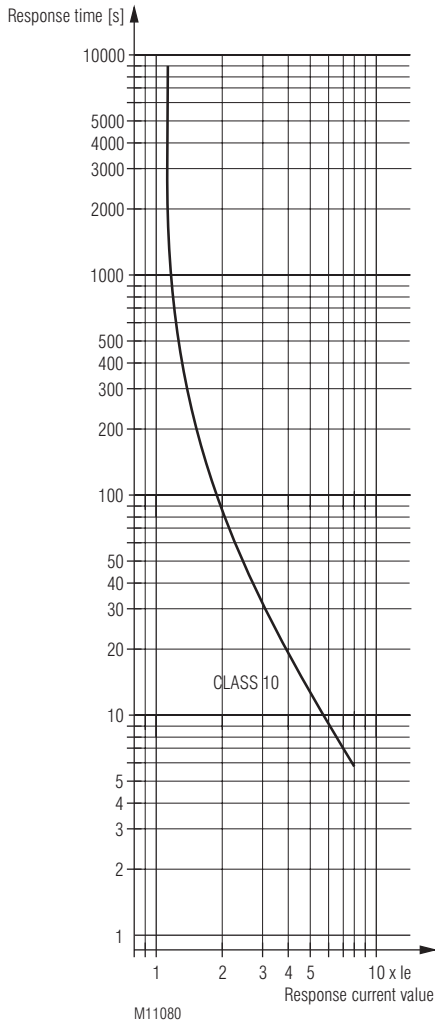

Trigger characteristics

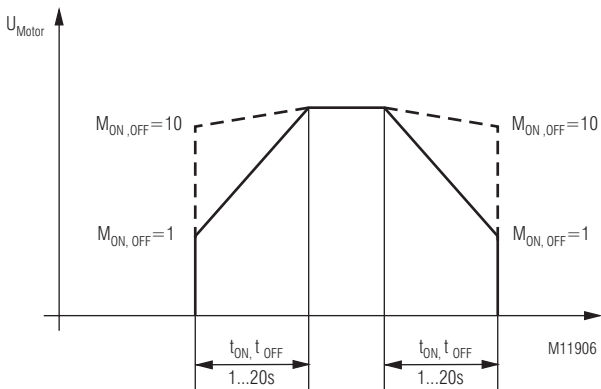

Characteristics without Kickstart function

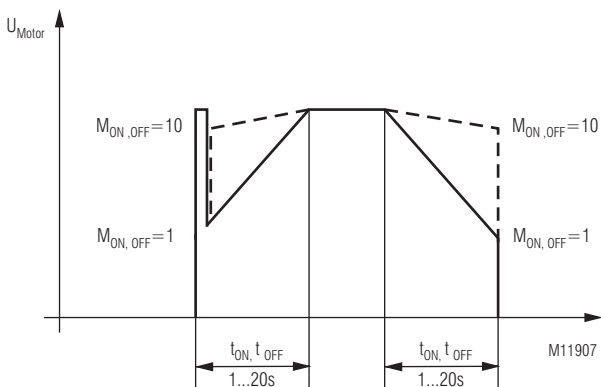

Characteristics with Kickstart function

Inbetriebnahme

Operation mode:

Select the required operating mode with potentiometer "BA".

Motor protection:

Set potentiometer I_g to rated motor current.

Softstart:

1. Start the motor via control input X1/X2 and turn potentiometer " M_{on}/M_{off} " up until the motor starts to turn without excessive humming.

2. Adjust potentiometer " t_{on}/t_{off} " to give desired ramp time.

Softstop:

- During softstop the device has to be connected to the voltage.
- Select softstop by opening control input X1/X2.
- The softstop time is identical with the softstart time "ton-/toff-time".

Connection Example

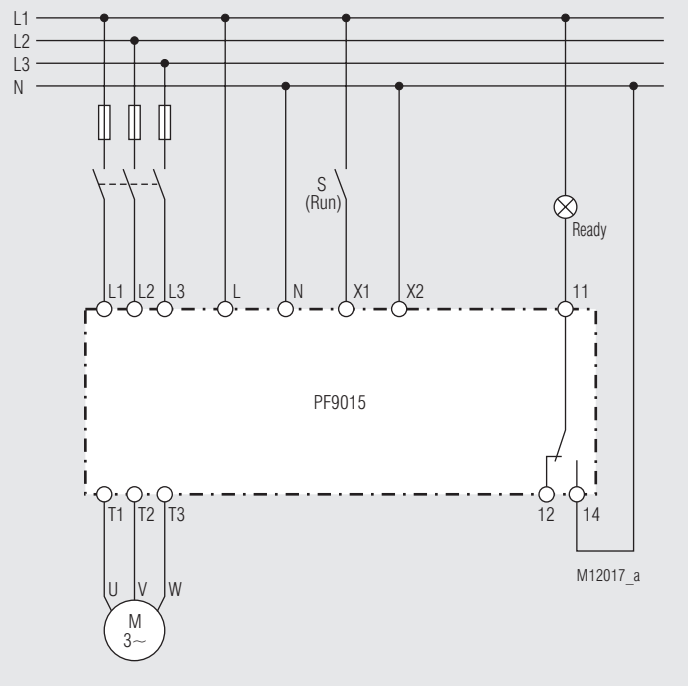

! Safety Instructions



Dangerous voltage.

Electric shock will result in death or serious injury.



Disconnect all power supplies before servicing equipment.

- Never clear a fault when the device is switched on
- The user must ensure that the device and the necessary components are mounted and connected according to the locally applicable regulations and technical standards
- Adjustments may only be carried out by qualified specialist staff and the applicable safety rules must be observed.
- Please note, that even if the motor is at rest, it is not physically separated from the mains. Because of this the motor must be disconnected from the mains.

Dimensions

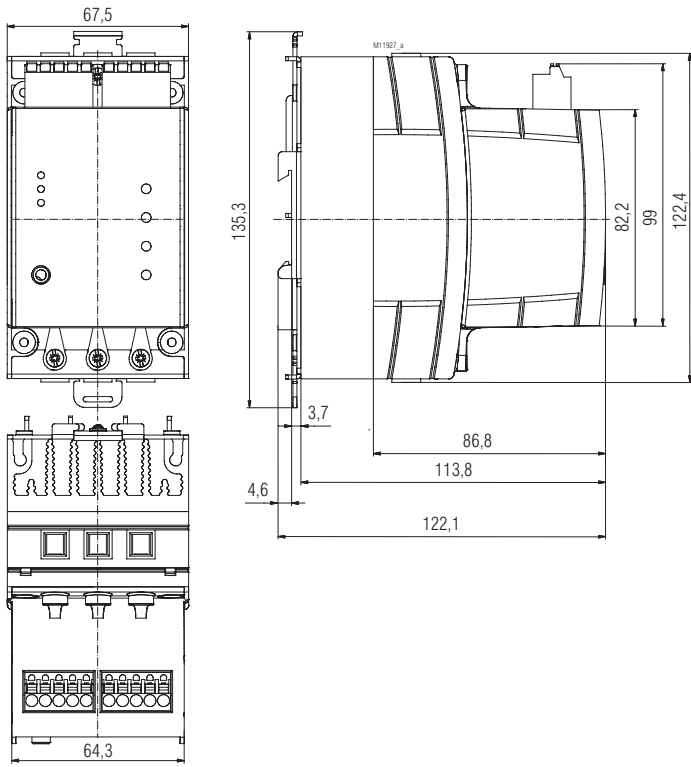

PF 9015 with heat sink