

Safety Relays

OA 5642, OA 5643, OA 5644

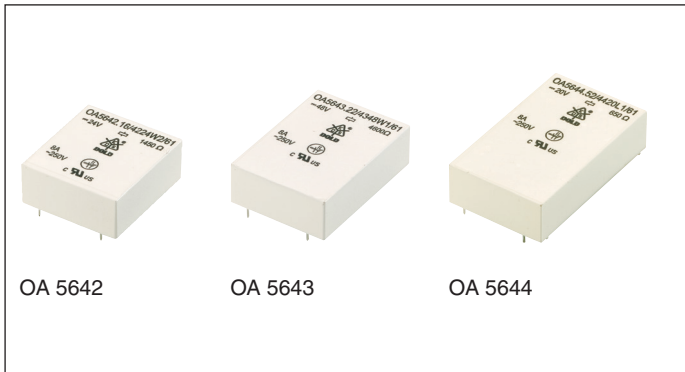

- According to DIN EN 61810-1, DIN EN 61810-3, DIN EN 45545 (fire protection on railway vehicles)
- With forcibly guided contacts
- Safe separation between coil/contact and contact/contact for applications at pollution degree 2 with rated insulation voltage 250 V
- Clearance and creepage distances
contact - coil ≥ 5.5 mm
contact - contact ≥ 5.5 mm
- Low nominal and holding power
- High mechanical service life
- **Extremely smallest height only 10.3 mm and minimum area**
- RoHS compliance
- Placing SMD components between PCB and relay is possible

Applications

- Switchgear for safety technology
- Press controls
- Escalators and walkways EN 115
- Elevators EN 81-1
- Railway technique

Approvals and Markings

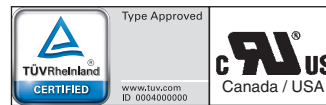

Technical Data

Relay type		OA 5642	OA 5643	OA 5644
1.0 Relay coil				
1.1 Nominal voltage	DC V	6; 12; 21; 24; 48; 60; 110; others on request		
1.2 Nominal consumption	W	0.40	0.50	0.65
1.11 Voltage range	U_N	0.7 ... 1.6	0.7 ... 1.6	0.7 ... 1.6
1.12 Thermal resistance	K/W		65 ± 10	
1.13 Holding power (at 0,5 x U_N)	W	0.1	0.125	0.160
2.0 Contacts				
2.1 Contact arrangement		1 NO / 1 NC	2 NO / 1 NC	2 NO / 2 NC 3 NO / 1 NC
2.2 Contact material		AgSnO ₂ + 0.2 μ m Au; AgNi + 0.2 μ m Au, AgNi + 5 μ m Au		
2.3 Rated insulation voltage	AC V	250		
Switching voltage min./max	V	AC 10; DC 10 / DC 250, AC 400 (AC/DC 2 V / AC/DC 60 V) ¹⁾		
2.4 Limit. contin. current I_{th} max. (each contact)	A	8		
Switching current min./max	A	10 mA ²⁾ / 8 A (2 mA / 0.3 A) ¹⁾		
2.5 Switching power min./max.	VA	0,1 ²⁾ / 2000 (10 mVA / 12 VA) ¹⁾		
Switching power min./max	W	0,1 ²⁾ ... 200 (10 mW / 12 W) ¹⁾ (see arc limit curve under resistive load)		
2.6 Switching capacity to IEC/EN 60947-5-1				
AC 15 ³⁾	V/A	NO 250 / 3	NC 250 / 1	
AC 15 ⁴⁾	V/A	NO 250 / 5	NC 250 / 2	
DC 13 ³⁾	V/A	NO 24 / 2	NC 24 / 2	
DC 13 ³⁾ at 0,1 Hz	V/A	NO 24 / 4	NC 24 / 4	
to UL 508		B300 / Q300		
2.7 Electrical life				$> 10^5$
at AC 230 V, 8 A, $\cos\phi = 1$	switching cycles	at 1 s On, 1 s Off (see diagram)		
2.8 Switching frequency max.	switching cycles/s	20		
2.9 Response time / Release time	ms	typ. 10 / typ. 5		
2.14 Contact gap	mm	1.0 ... 1.2 (> 0.5 ⁵⁾) $\hat{=}$ micro contact gap		
3.0 Other				
3.1 Mechanical life	switching cycles	$> 40 \times 10^6$		
3.2 Temperature range	$^{\circ}$ C	- 40 ... + 85		
3.3 Degree of protection		Wash proof RT III		
3.4 Test procedure		A (group mounting)		
3.5 Vibration resistance		10 ... < 60 Hz, a = 0,35 mm IEC/EN 60068-2-6		
Criteria: contact opening ≥ 10 μ s		60 ... 200 Hz, 5g (all contacts) IEC/EN 60068-2-6		
3.6 Climate resistance		040 / 085 / 21; A / B / D IEC/EN 60068-1		
3.7 Short circuit strength		1 kA / AC 250 V IEC/EN 60947-5-1 ^{3) 4)}		
SCPD / Fuse		NO contacts: 10 A gG/gL / NC contacts: 6 A gG/gL IEC/EN 60269 ^{3) 4)}		

¹⁾ Values for AgNi-contacts + 5 μ m Au

²⁾ Typical values for AgNi and AgSnO₂

³⁾ Values for AgNi

⁴⁾ Values for AgSnO₂

⁵⁾ over entire service life, even when under fault and at 1.6 x U_N

Technical Data

3.8	Insulation according to IEC 60664-1				
	Rated insulation voltage	AC V		250	
	Pollution degree			2	
	Overvoltage category			III	
	Test voltage				
	Contact- Coil (1 min)	AC kV eff.		≥ 4	
	Contact - Contact (1min)	AC kV eff.		≥ 4	
	between open contacts	AC kV eff.		≥ 1,5	
	Transient voltage				
	Contact- Coil (1,2 - 50 μs)	kV		≥ 6	
	Contact - Contact (1,2 - 50 μs)	kV		≥ 6	
	Clearance and creepage distances				
	Contact- Coil	mm		≥ 5.5	
	Contact - Contact	mm		≥ 5.5	
3.9	Weight	g	approx. 14	approx. 15	approx. 16
4.0 Packing					
4.1	on cardboard in slipcase	piece	32	28	20
4.2	in case package	piece	320	280	200
5.0 Solder method					
5.1	Solder method /-temperature /-duration	°C / s	Wafer soldering / 260 / 5		

Design Versions

U _N (DC V)	Voltage range (DC V)	OA 5642		OA 5643		OA 5644		
		R _{Coil} Ω±10%	.16 1NO, 1NC	R _{Coil} Ω±10%	.22 2NO, 1NC	R _{Coil} Ω±10%	.48 3NO, 1NC	.52 2NO, 2NC
AgSnO ₂ -contacts + 0,2 μm Au								
6	4.2 ... 9.6	90	4231	70	4331	55	4431	4531
12	8.4 ... 19.2	370	4232	290	4332	220	4432	4532
21	15.0 ... 33.6	1050	4233	840	4333	680	4433	4533
24	16.8 ... 38.4	1450	4234	1150	4334	900	4434	4534
48	33.6 ... 76.8	6000	4235	4600	4335	3600	4435	4535
60	42.0 ... 96.0	9250	4236	7100	4336	5600	4436	4536
110	77.0 ... 176.0	31000	4237	24000	4337	18500	4437	4537
AgNi-contacts + 0.2 μm Au								
6	4.2 ... 9.6	90	4201	70	4301	55	4401	4501
12	8.4 ... 19.2	370	4202	290	4302	220	4402	4502
21	15.0 ... 33.6	1050	4203	840	4303	680	4403	4503
24	16.8 ... 38.4	1450	4204	1150	4304	900	4404	4504
48	33.6 ... 76.8	6000	4205	4600	4305	3600	4405	4505
60	42.0 ... 96.0	9250	4206	7100	4306	5600	4406	4506
110	77.0 ... 176.0	31000	4207	24000	4307	18500	4407	4507
AgNi-contacts + 5 μm Au								
6	4.2 ... 9.6	90	4221	70	4321	55	4421	4521
12	8.4 ... 19.2	370	4222	290	4322	220	4422	4522
21	15.0 ... 33.6	1050	4223	840	4323	680	4423	4523
24	16.8 ... 38.4	1450	4224	1150	4324	900	4424	4524
48	33.6 ... 76.8	6000	4225	4600	4325	3600	4425	4525
60	42.0 ... 96.0	9250	4226	7100	4326	5600	4426	4526
110	77.0 ... 176.0	31000	4227	24000	4327	18500	4427	4527

Ordering Example

OA 5642... / ... W 1 / 61*)

Pin configuration

W = wash proof RT III

Design version

Contact arrangement
.16 1 NO / 1 NC

*) / 61 cURus approval

Characteristics

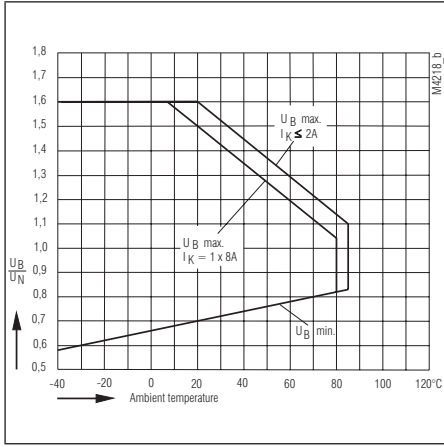

Operating voltage limit curve
OA 5642.16

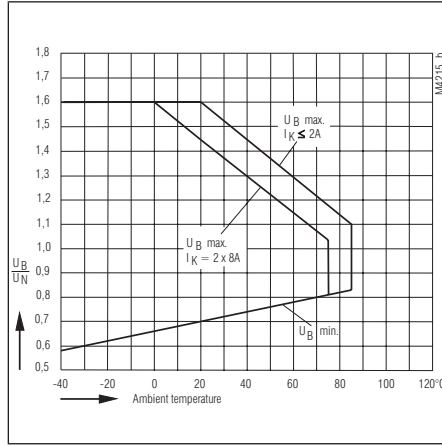

Operating voltage limit curve
OA 5644.52 und OA 5643.22

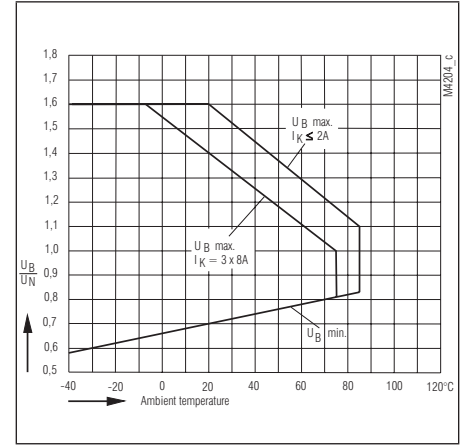

Operating voltage limit curve
OA 5644.48

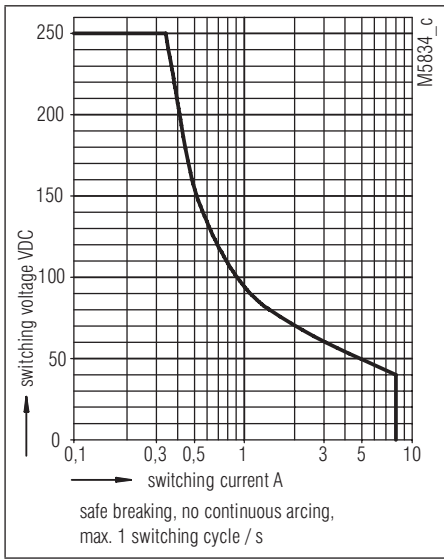

Limit curve for arc-free operat. (load limit curve)

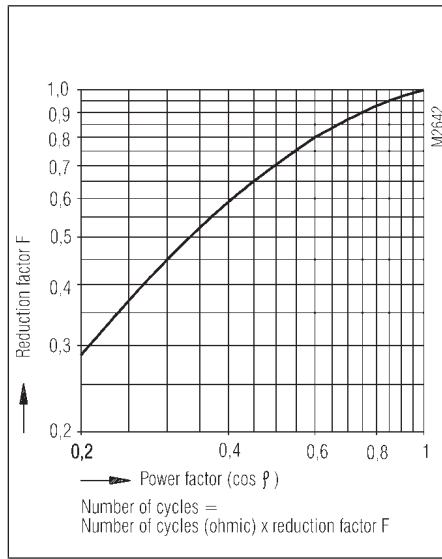

Reduction factor for inductive loads

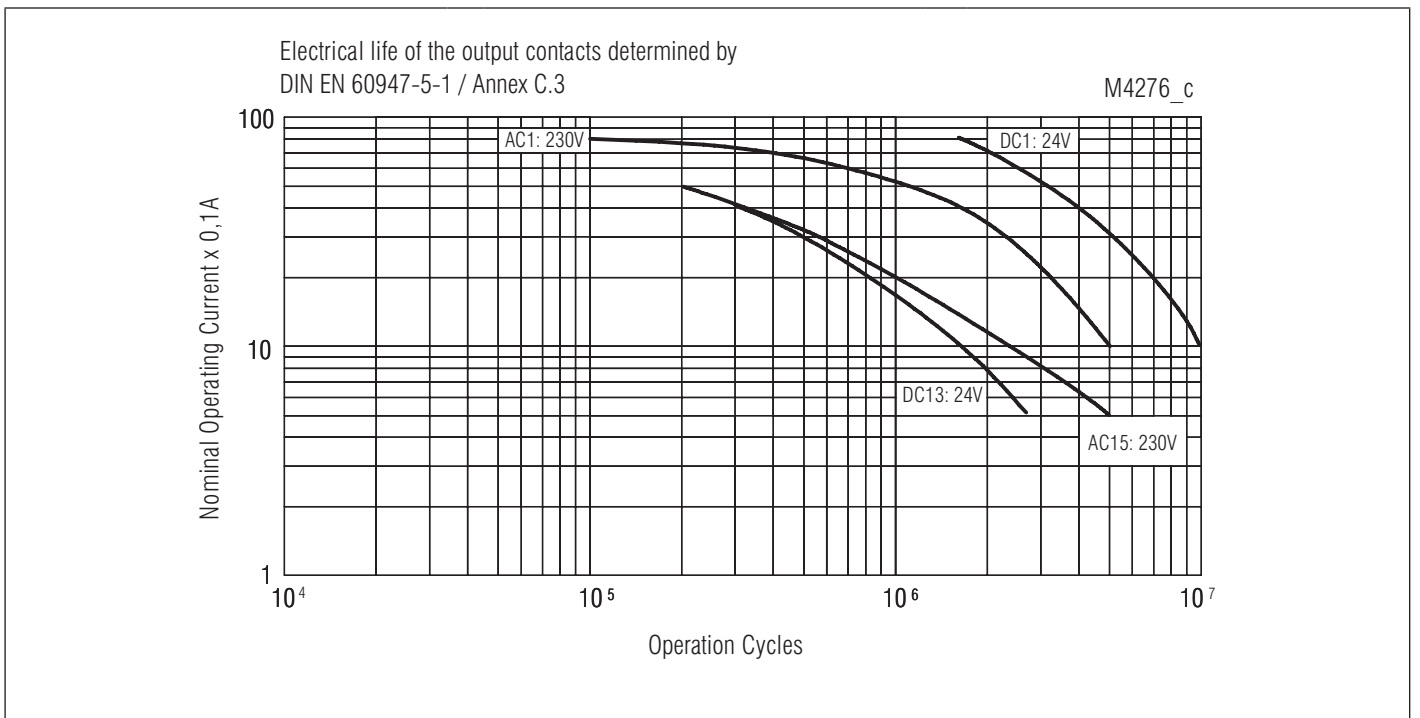

Electrical life

OA 5642 Dimensions, Pin Configuration, Connection Diagrams

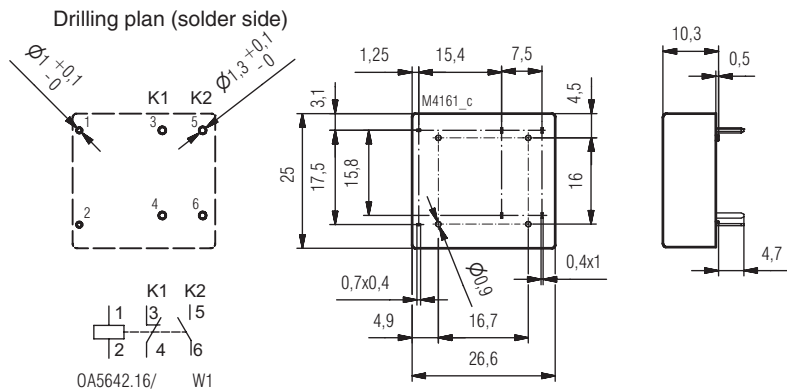

OA 5643 Dimensions, Pin Configuration, Connection Diagrams

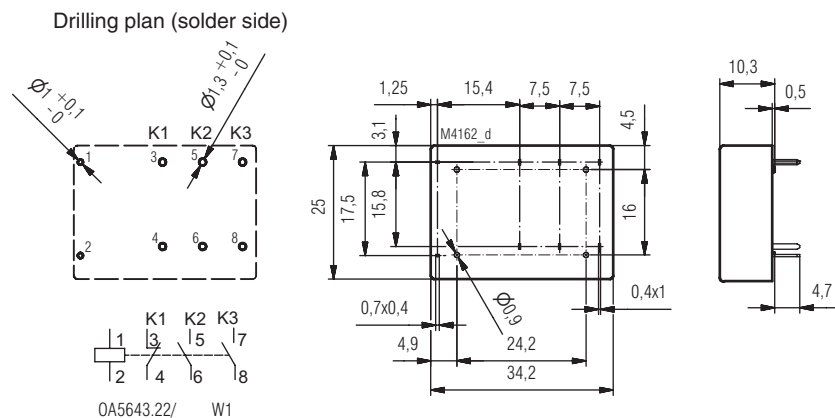

OA 5644 Dimensions, Pin Configuration, Connection Diagrams

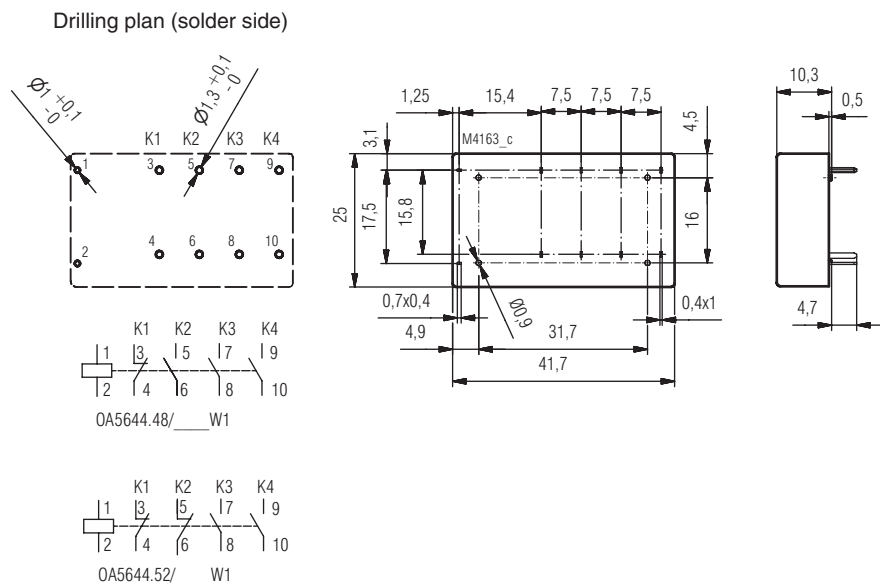

Notes

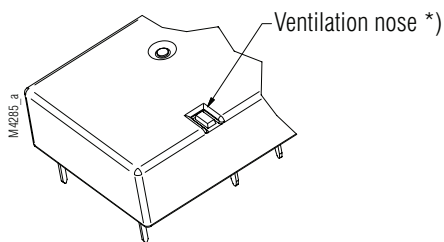

*) When using the maximum switching capacity it is recommended to open the relay at the indicated position.