

VARIMETER IMD Insulation Monitor IN 5880/711, IP 5880/711

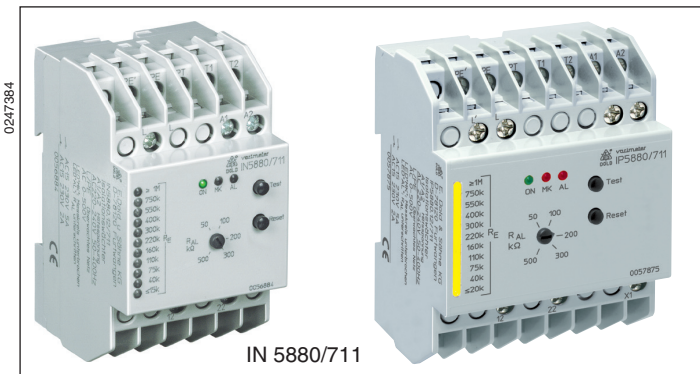

- According to IEC/EN 61 557-8
- For rooms used for medical purposes according to IEC 60364-7-710, DIN VDE 0100-710
- For three-phase and A.C. power systems with 0 ... 500 V and 10 ... 1000 Hz (IT power systems)
- Adjustable alarm value for ground fault R_{AL} of 50 ... 500 k Ω
- Measuring circuit with broken wire protection
- As option, programmable for storing or non-storing of errors
- With reset and test button
- Additional external reset and test buttons can be connected
- LED indicators for operation, insulation fault, and interruption of Measuring circuit
- 2 changeover contacts
- With LED chain for indication of the current insulation status
- IP 5880/711 for connection of the test and display panel UP 5862
- 52.5 mm width

Circuit Diagrams

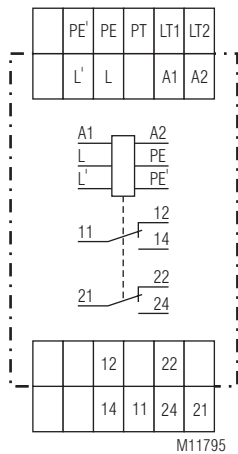

IN 5880/711

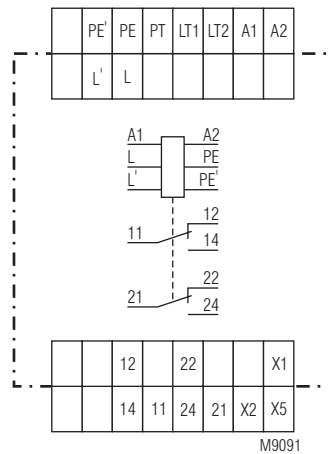

IP 5880/711

Connection Terminals

Terminal designation	Signal designation
A1, A2	Auxiliary voltage
L / L'	Connection for monitored IT-systems
PE / PE'	Connection for protective conductor
PT	Connection for external test button
LT1, LT2	Connections for external reset or manual and auto reset: LT1/LT2 bridged: hysteresis function LT1/LT2 not bridged: manual reset
X1, X2, X5 *)	Connections for external Test and indication panel UP 5862 *)
11, 12, 14 21, 22, 24	Alarm signal relay (2 changeover contact)

*) At IP 5880/711 only

Approvals and Markings



Applications

For insulation monitoring of the IT system of rooms used for medical purposes according to VDE 0100-710:

Function

The terminals L/L' and PE/PE' are connected to the respective lines of the IT power system. If the IT transformer has a centre tapping or a star point, the terminals L / L' are preferably connected to this point. The terminals L' and PE' should be connected with separate lines and possibly not in the same place (at least not at the same terminal) of the IT power system to allow for safe recognition of an interruption in the measuring circle.

The insulation resistance of the IT power system against ground is measured between the terminals L / L' and PE / PE'. If the ground fault resistance R_E falls below the pickup value R_{AL} of the line isolation monitor, the red LED "AL" will be illuminated, and the two changeover contacts fall back into normal position. On interruption of the Measuring circuit, the two changeover contacts will likewise fall back into normal position, and the red LED "MK" will be illuminated.

After correction of the error ($R_E > R_{AL}$, Measuring circuit connected) and jumpered terminals LT1 – LT2 (= error not stored), the changeover contacts will change into work position (correct status), and the red error LEDs will stop lighting.

If you wish to store errors, remove the jumper LT1 – LT2. In this way, also short-lived errors as e.g. a temporary deterioration of insulation, for example by touching of a line or unreliable contact making in the Measuring circuit may trigger a stored alarm: The output contacts remain open also after the error has been corrected. The type of the error can be seen in retrospect from the illuminated error LED "AL" or "MK".

The error memory can be reset by pressing the internal or external reset key, or by switching off the auxiliary voltage.

By pressing the internal or external "Test" key, a deterioration of insulation is simulated in the Measuring circuit (= R_E approx. 40 k Ω); thus, the correct response of the isolation monitor is checked.

The IN 5880/711 comprises an 11-stage LED chain for indication of the current insulation resistance of the power system. By means of differently colored LEDs, the insulation status in the range of 20 k Ω ... 1 M Ω is indicated. In this way, deterioration of insulation can be detected even before an alarm is triggered.

The IP 5880/711 includes a 11 step LED indicator to monitor the actual state of the insulation, an additional power supply and relays to connect a test and indicator unit UP 5862. The width is 70 mm.

Function Diagram Insulation Monitoring System

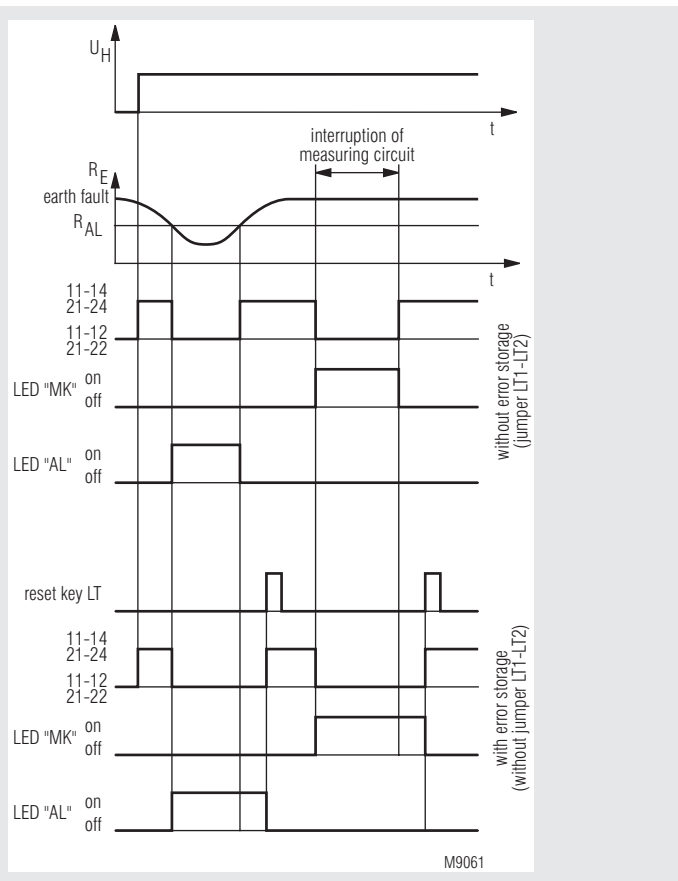

Notes

General

Before checking insulation and voltage of the system, disconnect the monitoring device IN 5880 from the power source.

Insulation monitoring system

The isolation monitor is designed to monitor straight AC power systems. Any interfering direct voltages getting into the Measuring circuit will not damage the device but will falsify the conditions in the Measuring circuit while they are affecting it. As insulation measuring is performed via direct current, it will not be falsified by system capacitances against protective ground C_E . However, the pickup time may be longer in case of insulation failure, in the order of the time constant R_E times C_E . In every IT circuit, only one isolation monitor must be connected. This has to be observed when coupling voltage system.

Indicators

Green LED "ON":	is illuminated when auxiliary voltage has been applied (operability)
Red LED "AL":	is illuminated when an insulation failure is present, $R_E < R_{AL}$ (value has fallen below alarm level)
Red LED "MK":	is illuminated when one of the lines of the Measuring circuit is interrupted (L, L', PE, PE')

11-stage LED chain:

Green LEDs:	at $\geq 1 \text{ M}\Omega$, 750 k Ω , 550 k Ω
Yellow LEDs:	at 400 k Ω , 300 k Ω , 220 k Ω , 160 k Ω , 110 k Ω , 75 k Ω
Red LEDs:	at 40 k Ω , $\leq 20 \text{ k}\Omega$

Technical Data

Insulation Measuring Circuit

Nominal voltage U_N:	AC 0 ... 500 V
Voltage range:	0 ... 1.1 U_N
Frequency range:	10 ... 1000 Hz,
Alarm value R_{AL}:	Adjustable from 50 ... 500 k Ω
Internal testing resistor:	corresponds to an R_E of approx. 40 k Ω
AC internal resistance:	> 250 k Ω
DC internal resistance:	> 250 k Ω
Measuring voltage:	approx. DC 15 V (generated internally)
Max. measuring current ($R_E = 0$):	< 50 μA
Response inaccuracy:	$\pm 15\% + 1.5 \text{ k}\Omega$ IEC 61557-8
Max. permissible interfering direct voltage:	DC 500 V
Operate delay:	with $R_{AL} = 50 \text{ k}\Omega$, $C_E = 1 \mu\text{F}$
R_E of ∞ to $0.9 R_{AL}$:	< 1.3 s
R_E of ∞ to 0 kΩ:	< 0.7 s
Hysteresis:	approx. 15%

Auxiliary Circuit

Auxiliary voltage U_H:	AC 220 ... 240 V
Voltage range:	0.85 ... 1.1 U_H
Nominal consumption	
IN 5880/711:	approx. 2.5 VA
IP 5880/711:	approx. 4 VA
Nominal frequency:	45 ... 400 Hz

Output

Contacts:	2 changeover contacts
Thermal current I_{th}:	4 A
Switching capacity	
acc. to AC 15	
NO contact:	5 A / AC 230 V IEC/EN 60 947-5-1
NC contact:	2 A / AC 230 V IEC/EN 60 947-5-1
Contact life	
to AC 15 with 1 A, AC 230V:	5 x 10 ⁵ operating cycles IEC/EN 60 947-5-1
Short circuit strength	
max. fuse rating:	4 A gL IEC/EN 60 947-5-1
Mechanical life:	> 30 x 10 ⁶ operating cycles

General Data

Nominal operation:	Permanent operation
Temperature range:	
Operation:	- 20 ... + 60 °C
Storage:	- 25 ... + 70 °C
Betriebshöhe:	< 2.000 m
Clearance and creepage distances	
overvoltage category/	
pollution degree:	4 kV / 2 IEC 60 664-1
Insulation test voltage	
Routine test:	AC 2,5 kV; 1 s
EMC	
Static discharge (ESD):	8 kV (air discharge) IEC/EN 61 000-4-2
HF irradiation	
80 MHz ... 1 GHz:	10 V / m IEC/EN 61 000-4-3
1 GHz ... 2.5 GHz:	3 V / m IEC/EN 61 000-4-3
2.5 GHz ... 2.7 GHz:	1 V / m IEC/EN 61 000-4-3
Fast transients:	2 kV IEC/EN 61 000-4-4
Surges	
between supply lines:	1 kV IEC/EN 61 000-4-5
between wire and ground:	2 kV IEC/EN 61 000-4-5
HF-wire guided:	10 V IEC/EN 61 000-4-6
Interference suppression:	Limit value class B EN 55 011
Degree of protection	
Housing:	IP 40 IEC/EN 60 529
Terminals:	IP 20 IEC/EN 60 529
Housing:	Thermoplast with V0 behavior according to UL Subject 94
Vibration resistance:	Amplitude 0.35 mm
Frequency 10 ... 55 Hz	IEC/EN 60 068-2-6
Climate resistance:	20 / 060 / 04 IEC/EN 60 068-1
Terminal designation:	EN 50 005

Technical Data

Wire connection:	DIN 46 228-1/-2/-3
Cross section:	2 x 2.5 mm ² solid, or 2 x 1.5 mm ² stranded wire with sleeve
Stripping length:	10 mm
Wire fixing:	Screw terminals with self-lifting clamping piece IEC/EN 60 999-1
Fixing torque:	0.8 Nm
Mounting:	DIN rail IEC/EN 60 715
Net weight	
IN 5880/710:	approx. 190 g
IN 5880/711:	approx. 250 g
IP 5880/711:	approx. 350 g

Dimensions

Width x height x depth

IN 5880/711:	52.5 x 90 x 59 mm
IP 5880/711:	70 x 90 x 59 mm

Standard types

IN 5880.12/711 AC 220 ... 240 V

- Artikelnummer: 0056884
- Output: 2 changeover contacts
 - Auxiliary voltage U_H : AC 220 ... 240 V
 - Width: 52,5 mm
 - Adjustable alarm value RAL: 50 ... 500 k Ω
 - With 11-stage LED chain for indication of the current insulation value

IP 5880.12/711 AC 220 ... 240 V

- Artikelnummer: 0057875
- Output: 2 changeover contacts
 - Auxiliary voltage U_H : AC 220 ... 240 V
 - Width: 70 mm
 - Adjustable alarm value RAL: 50 ... 500 k Ω
 - With 11-stage LED chain for indication of the current insulation value
 - In addition with connection for test and indicator panel UP 5862

Ordering Example

IN 5880.12/711	AC 220 ... 240 V	50 ... 500 k Ω	
			Alarm value
			Auxiliary voltage
			Type

Connection Example

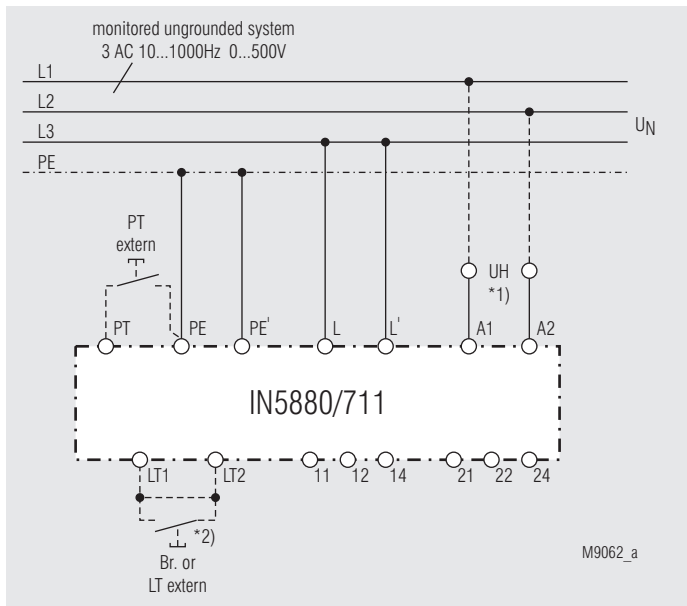

Monitoring of a 3-phase IT power system

Connection Example

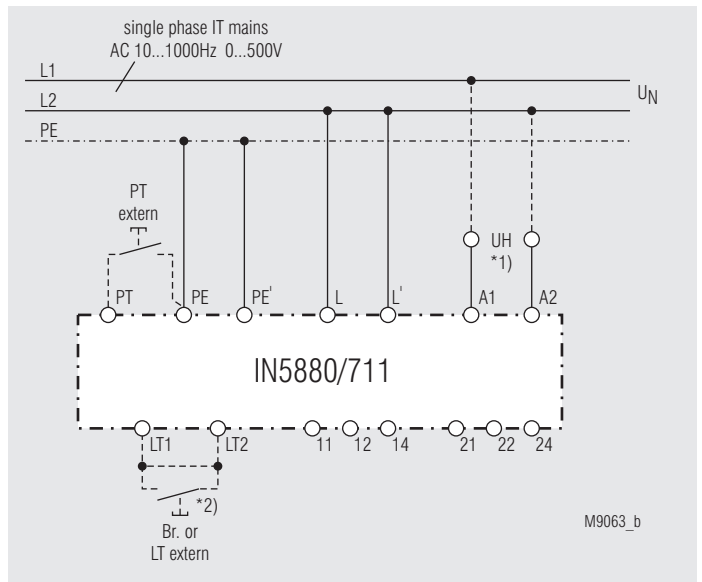

Monitoring of a single phase IT power system

*1) The auxiliary voltage U_H (A1 – A2) can also be drawn from the power system to be monitored. However, the voltage range of the auxiliary voltage must be taken into consideration.

*2) With jumper LT1 – LT2: No storing of error message (hysteresis behavior)

With jumper LT1 – LT2: Storing of error message; can be deleted by pressing the Delete (Reset) key LT

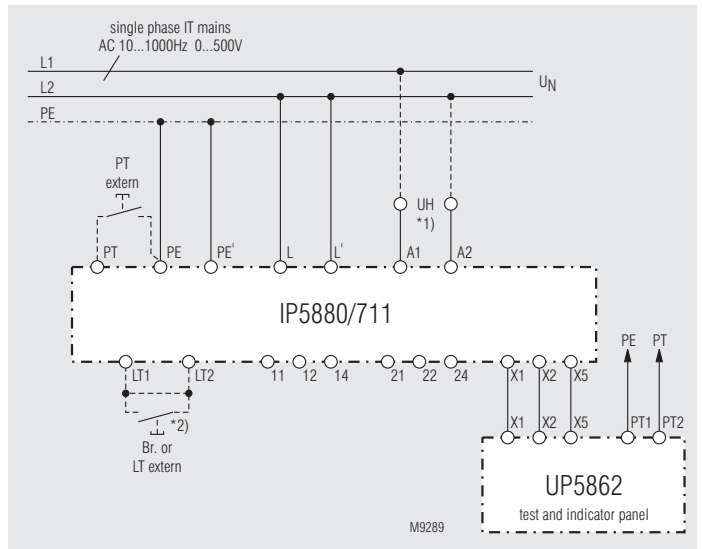

Monitoring of a single phase IT power system

Accessories

Test and indicator panel UP 5862

For insulation monitors in medically used rooms according to IEC 60 364-7-710, DIN VDE 0100-710



- to mount in flush device boxes
ø 60 mm, 35 mm deep;
- test button to check the function of the device
- with green LED to indicate operation
- reset button for audible alarm
- with yellow LED to monitor insulation failure

Max. wire length to IN / IP 5880

at wire cross section A = 0.5 mm²: 500 m

at wire cross section A = 1.5 mm²: 1000 m

Dimensions (width x height): 80 x 80 mm

Article number: 0041706

Flush mounting kit

Order reference: KU 4087-150/005659

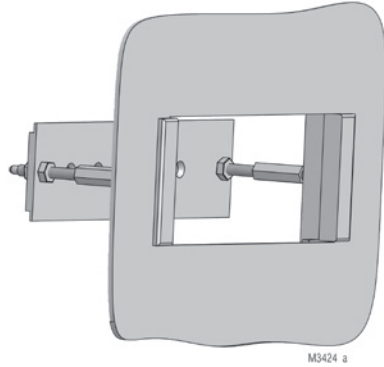

For universal use with:

- I-series devices of
17,5 to 105 mm width
- easy mounting

M3424_a

Mounting kit for surface mounting

KU 4087-100

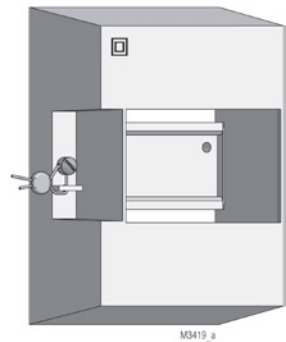

M3419_a

Device of I-series	Width (mm)	Order reference
IK	17.5	KU4087-100/56763
IL	35.0	KU4088-100/56764
IN	52.5	KU4084-100/56765
IP	70.0	KU4089-100/56766
IR	105.0	KU4090-100/56767