

## Multi-Function Safety System SAFEMASTER M Input Module BG 5913.08/\_0\_\_\_, BH 5913.08/\_0\_\_\_

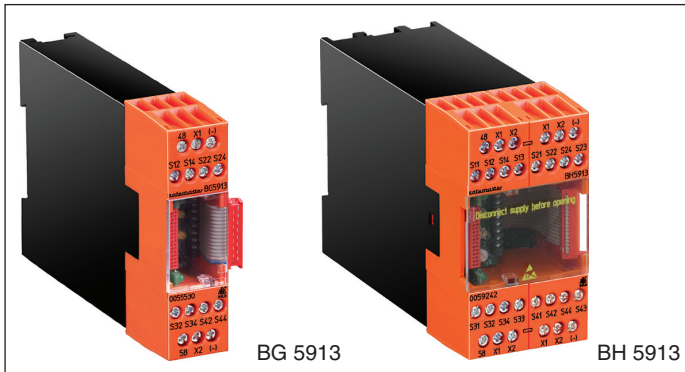

- According to
  - Performance Level (PL) e and category 4 to EN ISO 13849-1: 2008
  - SIL Claimed Level (SIL CL) 3 to IEC/EN 62061
  - Safety Integrity Level (SIL 3) to IEC/EN 61508
- Input module for realization of
  - 4 similar 2-channel inputs
  - Emergency stop circuits
  - Safety gate monitoring system
  - Two-hand control type IIIA, IIIC acc. to DIN/EN 574
  - Light curtain (LC type 4)
- The functions are selected via rotary switch
- 8 safety inputs
- 2 semiconductor outputs for status indication
- Broken wire and short circuit monitoring function with error indication
- LEDs for status indication
- Width
  - BG 5913.08/\_0\_\_\_: 22.5 mm
  - BH 5913.08/\_0\_\_\_: 45 mm

### Block Diagram

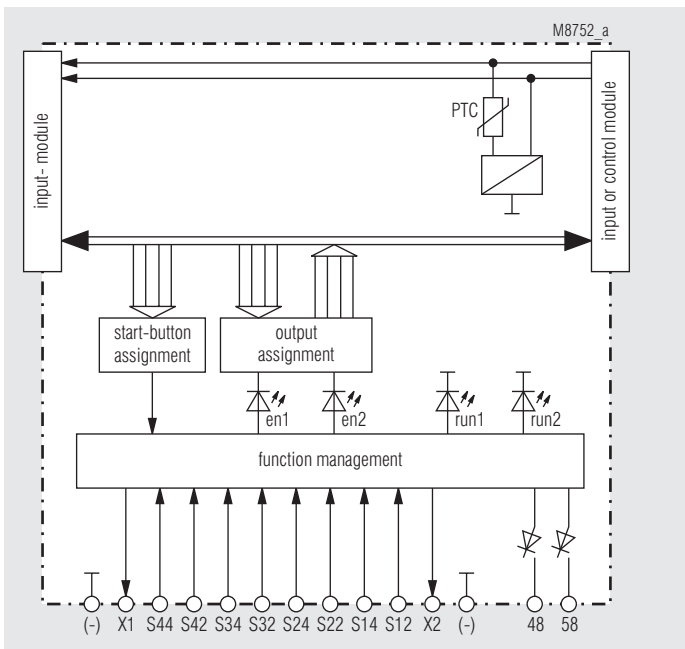

BG 5913

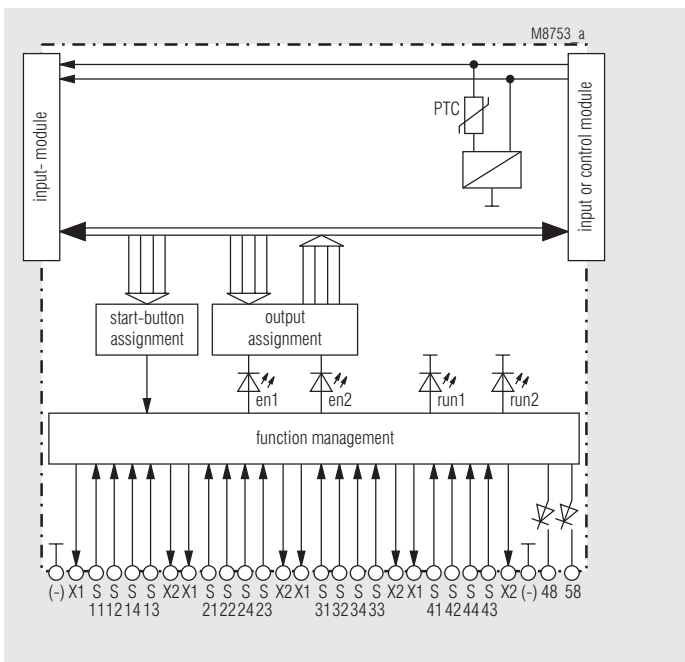

BH 5913

### Approvals and Markings



### Applications

Realization of fail-safe control circuits for protection of people and machinery.

Note: This module is intended for applications in which mixed safety functions affect one common output.

Further input modules with other combinations of functions are provided (e.g. BG 5913.08/\_1\_\_\_, BG 5913.08/\_2\_\_\_, BG 5913.08/\_3\_\_\_, BG 5914.08/\_0\_\_\_, BH 5914.08/\_0\_\_\_ or BG 5914.08/\_1\_\_\_).

### Circuit Diagrams

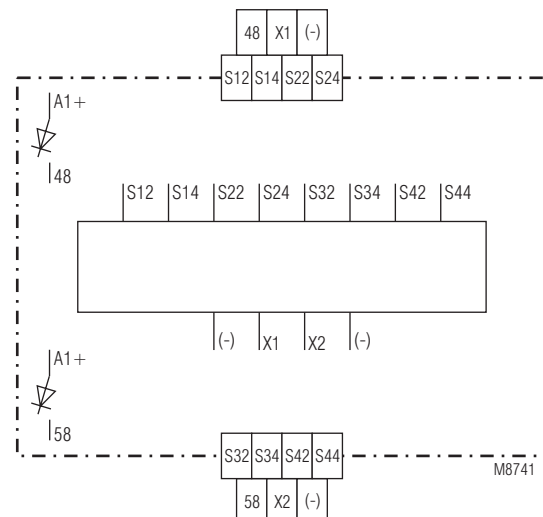

BG 5913

## Circuit Diagrams

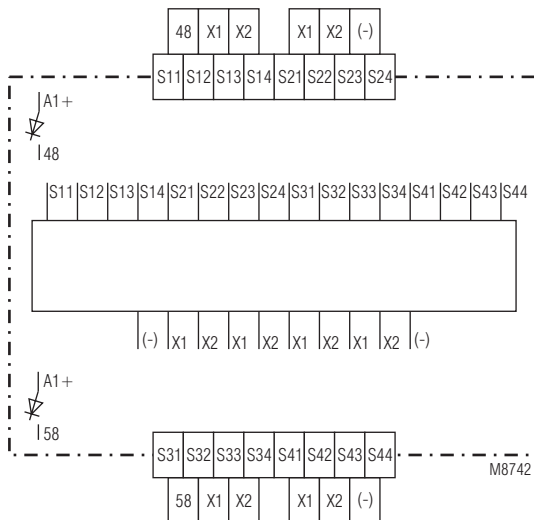

BH 5913

## General Information SAFEMASTER M

The maximum configuration of the SAFEMASTER M multi-function safety system is as follows:

- the control unit BH 5911
- up to 3 input modules BG/BH 5913, or BG/BH 5914, BG/BH 5915
- up to 3 output modules BG 5912
- 1 diagnostic module BG 5551 for CANopen, or
- 1 diagnostic module BG 5552 for Profibus-DP

The BH 5911 controls the whole system.

The input/output modules can be used to expand the control unit in a modular way into a multi-functional safety system.

To transmit status messages of the individual modules to a monitoring or control unit, one of the following diagnostic modules may be connected:

- BG 5551 for CANopen
- BH 5552 for Profibus-DP

## Notes

In respect of function and settings, the modules BG 5913 and BH 5913 are completely identical.

- The modules BG 5913 have 8 inputs with one common ground. This is the ground of the overall system. They are suitable for all applications in which volt free contacts are used, or where there is a common ground (e.g. 2-channel light curtains). They need only 8 terminals and thus only have an overall width of 22.5 mm.
- The modules BH 5913 have 8 completely DC-decoupled inputs. This allows with setting 1 and 3 (4 lightcurtains) to connect also 4 two-channel e-stop buttons with long connection wires with static signal potential. Here, short-circuit monitoring is effected by a certain type of wiring according to the application examples.

## Indication

Green LEDs: on, when all inputs are present and start button activated.

White LEDs Run1/  
Run 2 and outputs  
48 and 58: indicate the current status of the module.

## Setting of the Module

The module is assigned to the start inputs and the safety outputs via the DIP switches.

The combinations of individual functions are set via the rotary switches. To prevent accidentally adjustments, these elements are covered by a front plate and are redundant.

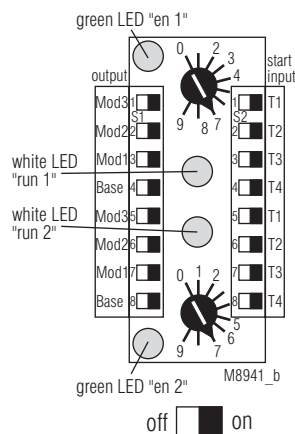
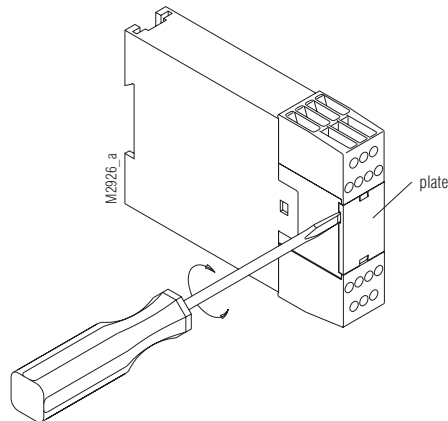

## Note:

- Settings to the unit must be performed by skilled personnel while the unit is disconnected.
- Before the front cover is removed, antistatic precautions must be observed.

## Setting of the Modules

Sw.	Function
0	4 Emergency stop 2-channel, autostart
1	4 light curtains category 4, autostart
2	4 Emergency stop 2-channel, manual start
3	4 light curtains category 4, manual start
4	4 safety gates with 2 single contacts
5	2 safety gates with 2 changeover contacts
6	1 safety gate with 2 twin contacts and 1 single contact, manual start (plastic injection moulding machines) to EN 201
7	1 safety gate with 3 twin contacts, manual start (plastic injection moulding machines) to EN 201
8	4* two-hand control IIIA acc. to EN 574
9	2* two-hand control IIIC acc. to EN 574

When using setting 8 or 9 the user has to indicate clearly on the device which type of 2-hand function is adjusted (IIIA or IIIC).

### Automatic Start

Automatic start is performed only when supply voltage is switched on, or when the emergency stop or stop function has been reset. All other errors nevertheless require confirmation by a start input.

### Manual Start

To start the system, do not keep the start key pressed for more than 3 seconds. A module may also be assigned several start keys.

### One-Channel Input

With setting 6), it is imperative to use a voltfree contact for the single contact. A static signal cannot be used.

### Simulation Input for Function of Safety Gates

When the unit is set to monitor safety gates according to EN 201 switch position 4, 5, 6 and 7, closing of the assigned safety outputs is only enabled, if every gate has changed from open state (all contacts inactive) to closed state within a maximum period of 3 sec on each gate.

When the system is powered up with some gates open and some closed the open gates can be closed and the system can be started up by the simulation button, simulating an open-close cycle of the previously closed gates.

Only those gates are simulated, that had been closed before the system was powered up.

Simulation is only possible once after the unit is powered up. After that all contacts of a gate have to be opened and reclosed to enable the outputs again. When closing the gate all contacts of a gate have to close within 3 sec.

### Function of the Two-Hand Control

Up to 4 pairs of two-hand safety circuits can be connected with the two-hand safety function. However, no more than one circuit may be activated. To permit enabling of the assigned safety outputs, the following conditions must be fulfilled:

- 1) First, none of the connected two-hands circuits must be activated.
- 2) Both buttons of a two-hand control must be pressed within 0.5 s.
- 3) When changeover contacts (type IIIC acc. to DIN / EN 574) are used for the two-hand-safety buttons, they must effect changeover of contacts within 50 ms.
- 4) As soon as a button of a second two-hand circuit is pressed, the outputs are disabled, and condition 1) must be fulfilled once more before a new enabling cycle can start.
- 5) The two-hand buttons have to be released if an other function module, also assigned to the same outputs disables the outputs.
- 6) Only one two-hand control module is allowed in one safemaster M system.

The unit must be connected as specified in the application examples. When the operating contacts are connected in parallel or in series, safe functioning of the unit is cancelled.

The two-hand buttons must be designed and arranged in such a way as to ensure that they cannot be disabled easily, or pressed unintentionally.

The safety distance between the push buttons and the place of danger must be large enough to insure that after releasing a button, the place of danger can only be reached after the dangerous movement has stopped. The safety distance "S" is calculated according to the following formula:

### Function of the Two-Hand Control

$$S = V \times T + C, \text{ where}$$

- a) gripping velocity  $V = 1\ 600\ \text{mm/s}$
- b) overtravel time  $T\ (\text{s})$
- c) and safety factor  $C = 250\ \text{mm}$ .

When any access into the dangerous area, with operating keys pressed, is safely prevented, e.g. by a protective cover for the keys, the safety factor C may be set to the value 0. Generally, the minimum safety distance must be 100 mm. See also DIN/EN 574.

### Safety Gate Function

The safety gate function always permits enabling if both contacts change from inactive to active state within 3 seconds. If the second contact reacts later, both changeover contacts must turn inactive before they can be enabled again.

When activating the system, press the start button to simulate the compulsory opening and re-closing of safety gates which have been kept closed since the system has started.

This simulation is possible only before enabling has been permitted for the first time, and as long as both safety gate contacts remain closed as well. As soon as a contact opens, simulation of the safety gate function is no longer possible.

### E-Stop or Light Curtain (LC) Function

In the Emergency stop or LC functions, both signals have to change from inactive state into active state within 250 ms. If the second signal reacts later, both changeover contacts must turn inactive before they can be enabled again.

With manual start, all safety inputs must be active before the start button can be pressed to trigger enabling. To start the system, do not keep the start button pressed for more than 3 seconds. A module may also be assigned several start buttons.

**Note:** Connect only self-testing light curtains of the type 4 acc. to EN 61496 to the module. Short-circuit monitoring of the inputs for the LC must be done in the LC.

### Indication of System Errors:

These errors are indicated by flashing codes of the white LEDs Run 1 and/or Run 2. The green LEDs and all outputs turn inactive. The system will only restart after the supply voltage has been switched off and on again.

### Error codes\*

- 0) (both white LEDs are off):  
Another input module indicates a system error.
- 1) To 4): not used
- 5) Incorrect setting of function:
  - The rotary switches for channel 1 and 2 has different or incorrect positions
  - The setting of the 4 upper Dip-switches (channel 1) are not identically to the 4 lower Dip-switches (channel 2)
- 6) LED Run 1 flashes: Undervoltage  
LED Run 2 flashes: Overvoltage
- 7), 8) Not used
- 9) Connection error between the input modules  
No terminating connector available.
  - Control or input module defective
- 10), 11), 12), 13) a. 14) Internal errors

\* number of short flashing impulses, followed by a longer space

Indication			
	Permanently OFF	Pulsing	Permanent ON
Output 48	all relays inactive due to system error	one input function not available	Activation of the assigned safety outputs is permissible
LED Run 1	Two-hand control not activated (LED run 2 ON) or all relays inactive due to system error	one input function not available (LED run 2 ON) or system error when LED Run 2 is OFF or flashing	Activation of the assigned safety outputs is permissible
Output 58	Activation of the assigned safety outputs is permissible or system error	Error exists no more, waiting for Start input	one input function not available
LED Run 2	all relays inactive due to system error	all relays inactive due to system error	No system error

### Function Error Indication

Function errors are indicated by the white LED Run 1 and by output 48; the white LED Run 2 remains on. Output 58 is ON as long as the error is pending; it flashes regularly, while waiting for the assigned start signal.

#### Error codes\*

- 1) Normal interruption of function (e.g. Emergency stop)
- 2) Time error: (e.g. the second two-hand button is not pressed)
- 3) With gate monitoring: simulation input error (kept pressed for too long)
- 4) Error at start input
- 5) Input error (short-circuit, interruption)
- 6) Error in the control unit (input or output error detected in the control unit)

\* number of short flashing impulses, followed by a longer space

#### Special with two-hand control:

When both two-hand buttons of the module are inactive while all other functions are active and enabled either by autostart or via the start button, output 48 and the white LED Run 1 are permanently OFF, and output 58 permanently ON.

## Function Diagramms

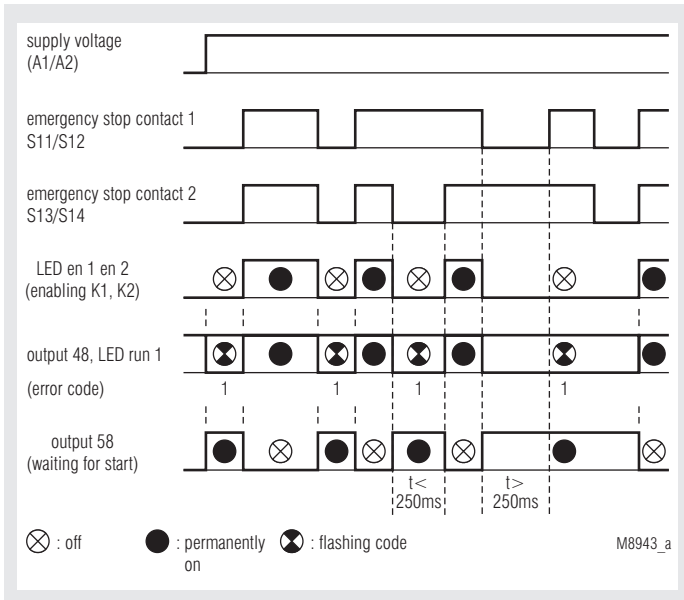

Emergency stop or light curtain, automatic start

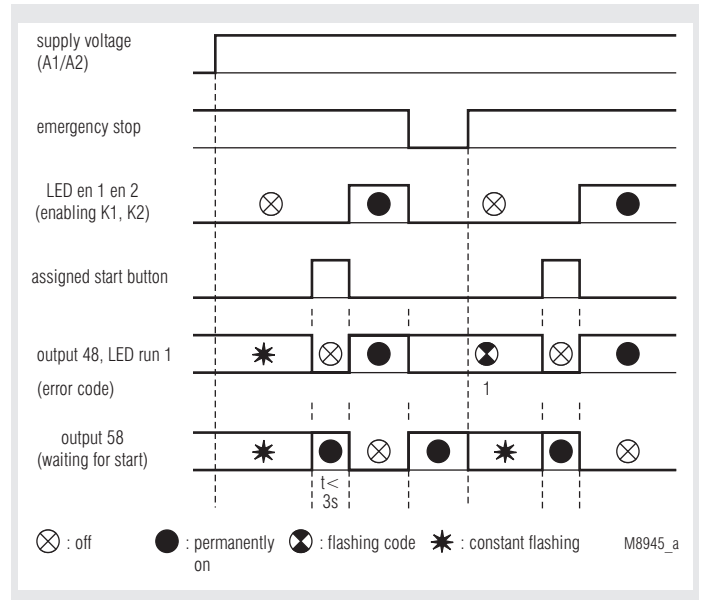

Emergency stop or light curtain, manual start

## Function Diagramms

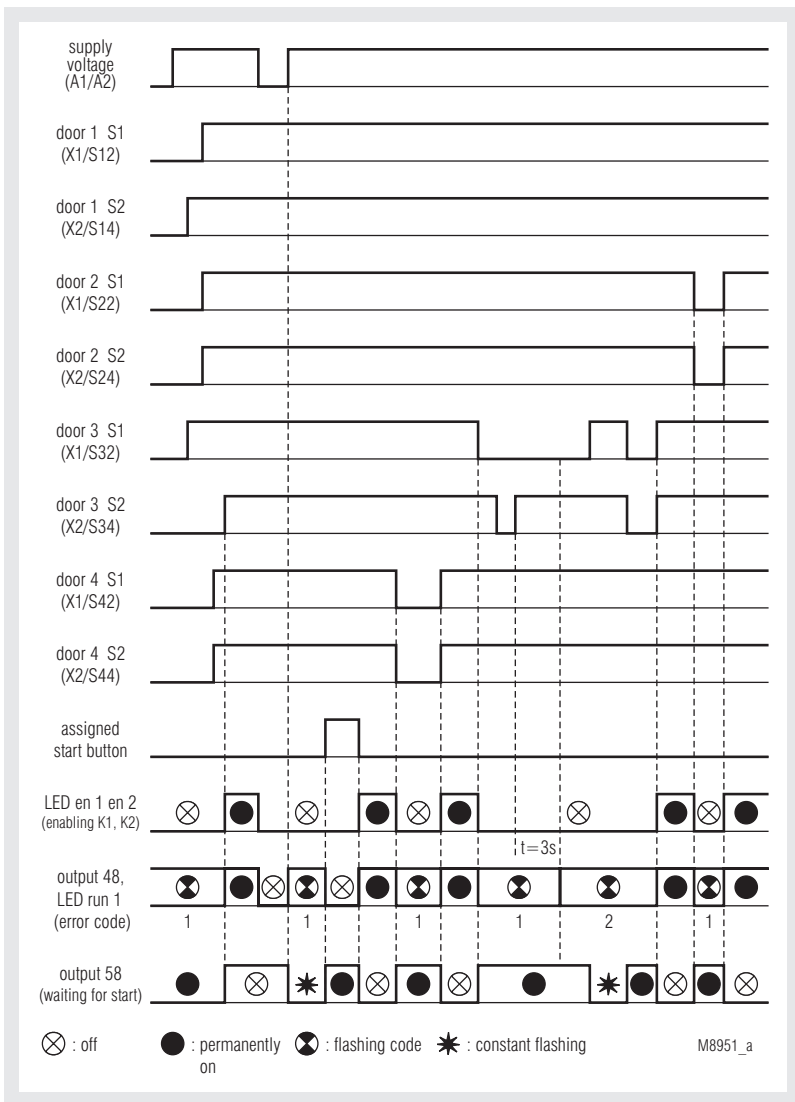

Safety gates (example: 4 gates with 2 single contacts each), assigned start buttons are also suitable for gate simulation (setting 4 or 5)

## Function Diagrams

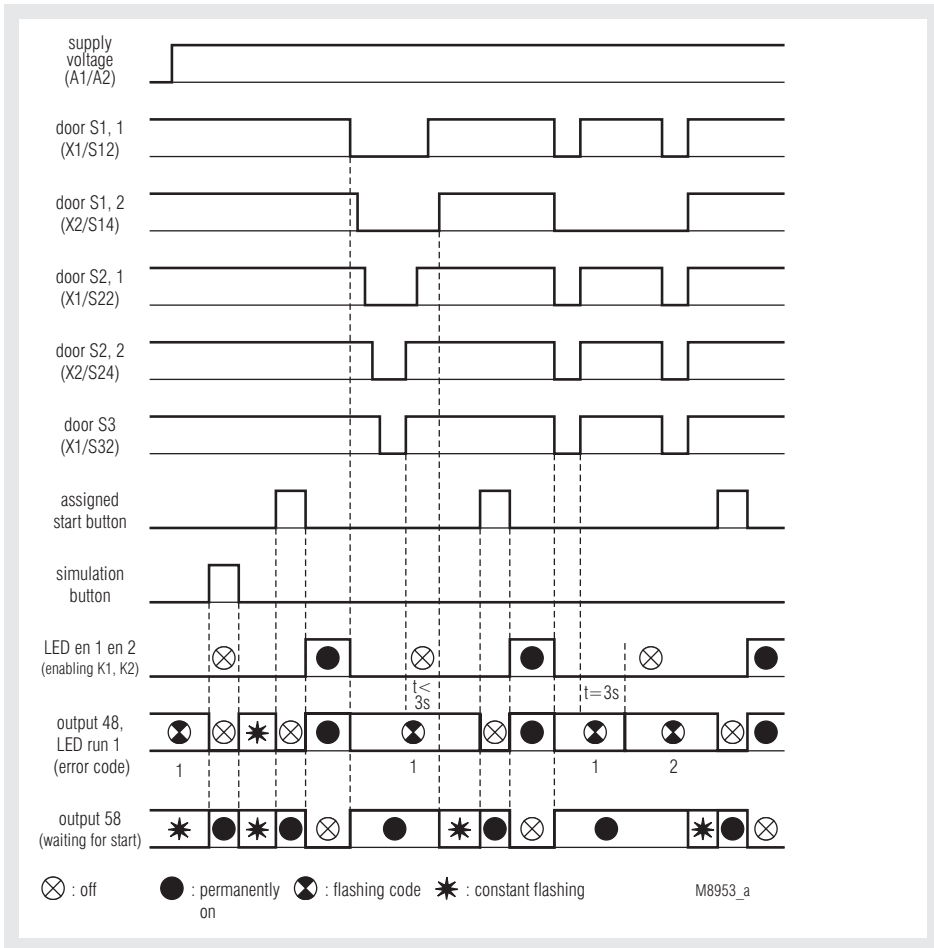

Safety gate for plastic moulding machines  
(example: 1 gate with double contacts + single contact) (setting 6 or 7)

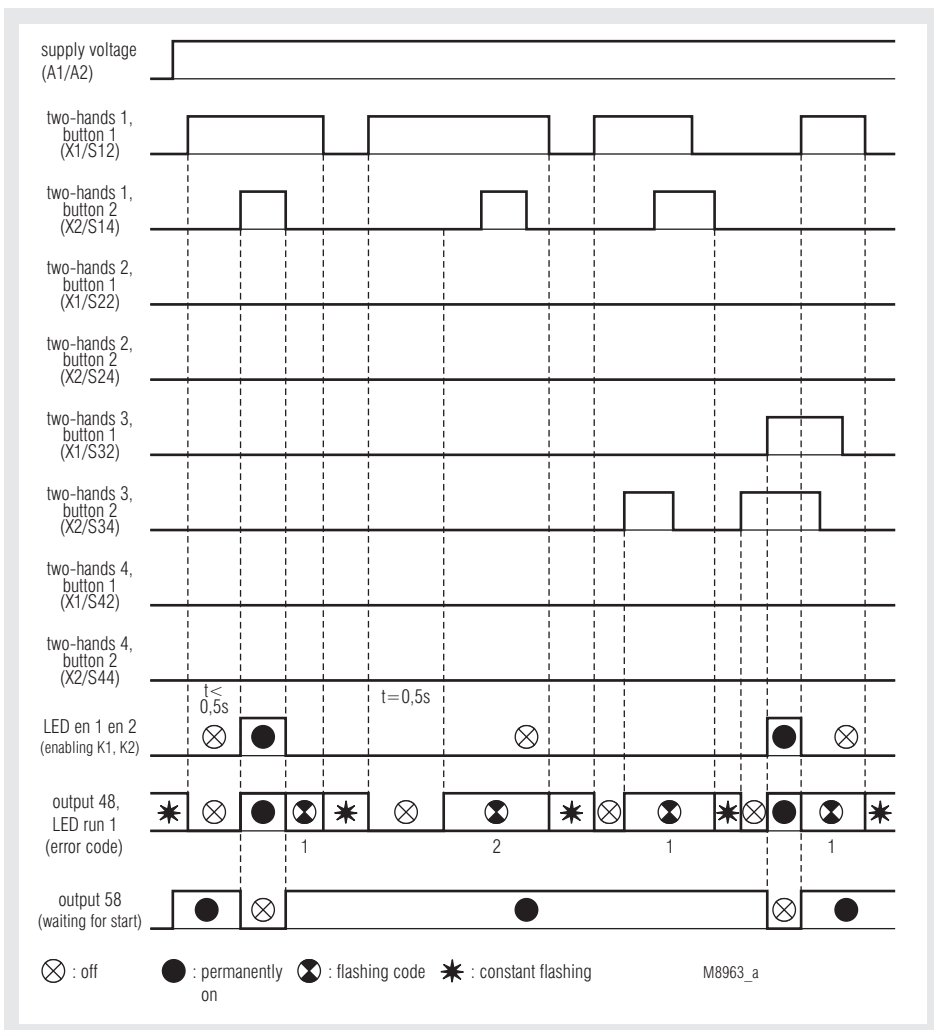

Two-hand control

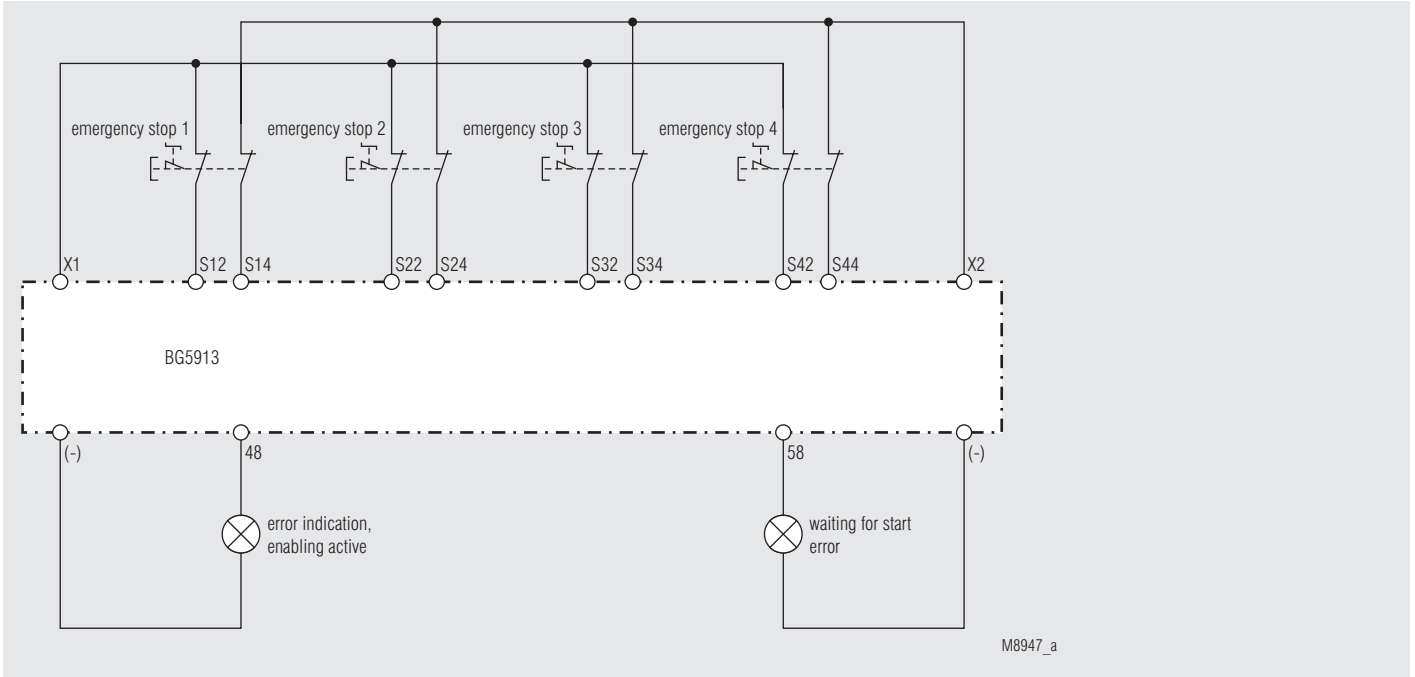

M8947\_a

4 Emergency stop circuits, 2-channel, auto/manual start with short circuit monitoring; function: 0, 2

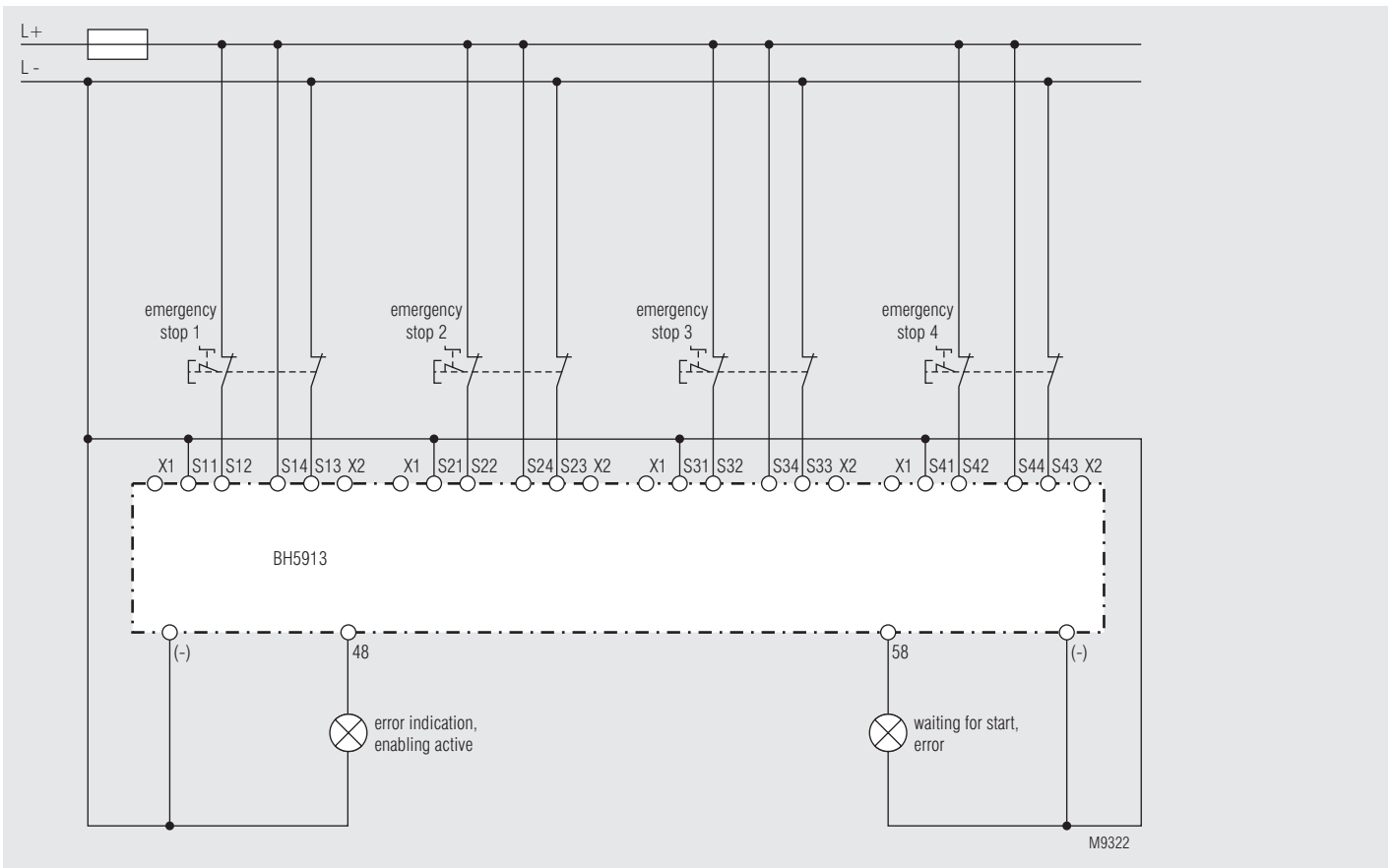

M9322

4 Emergency stop circuits, 2-channel, auto/manual start, short circuit monitoring by wiring; function 1, 3

## Application Examples

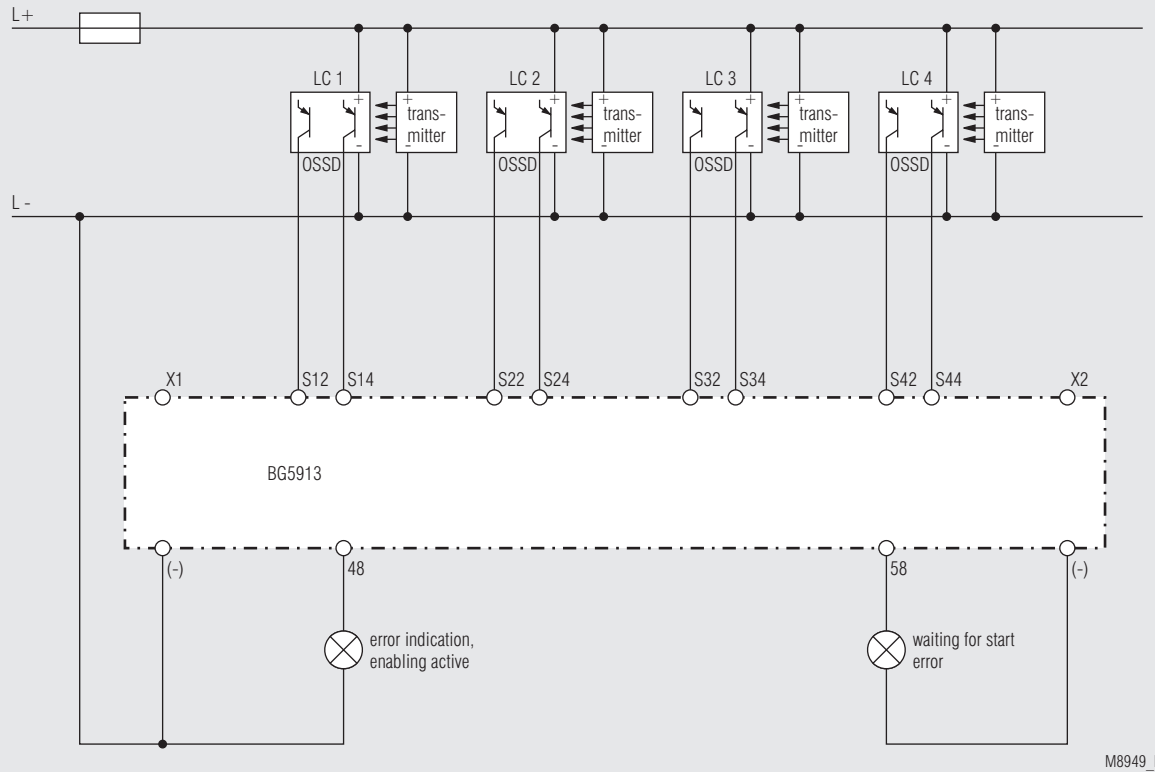

M8949\_b

4 light curtains, category 4, auto/manual start; function: 1,3

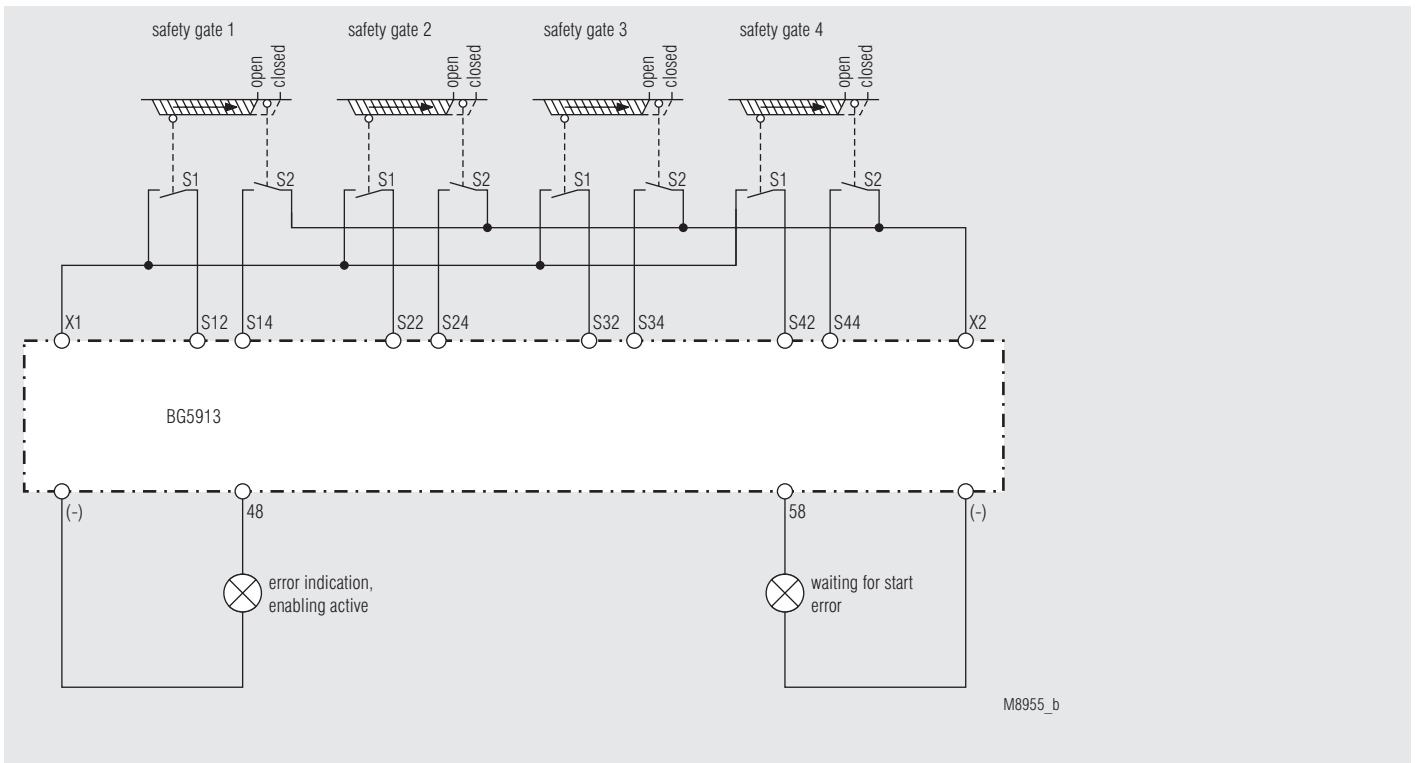

M8955\_b

4 safety gates with 2 NO contacts; function: 4



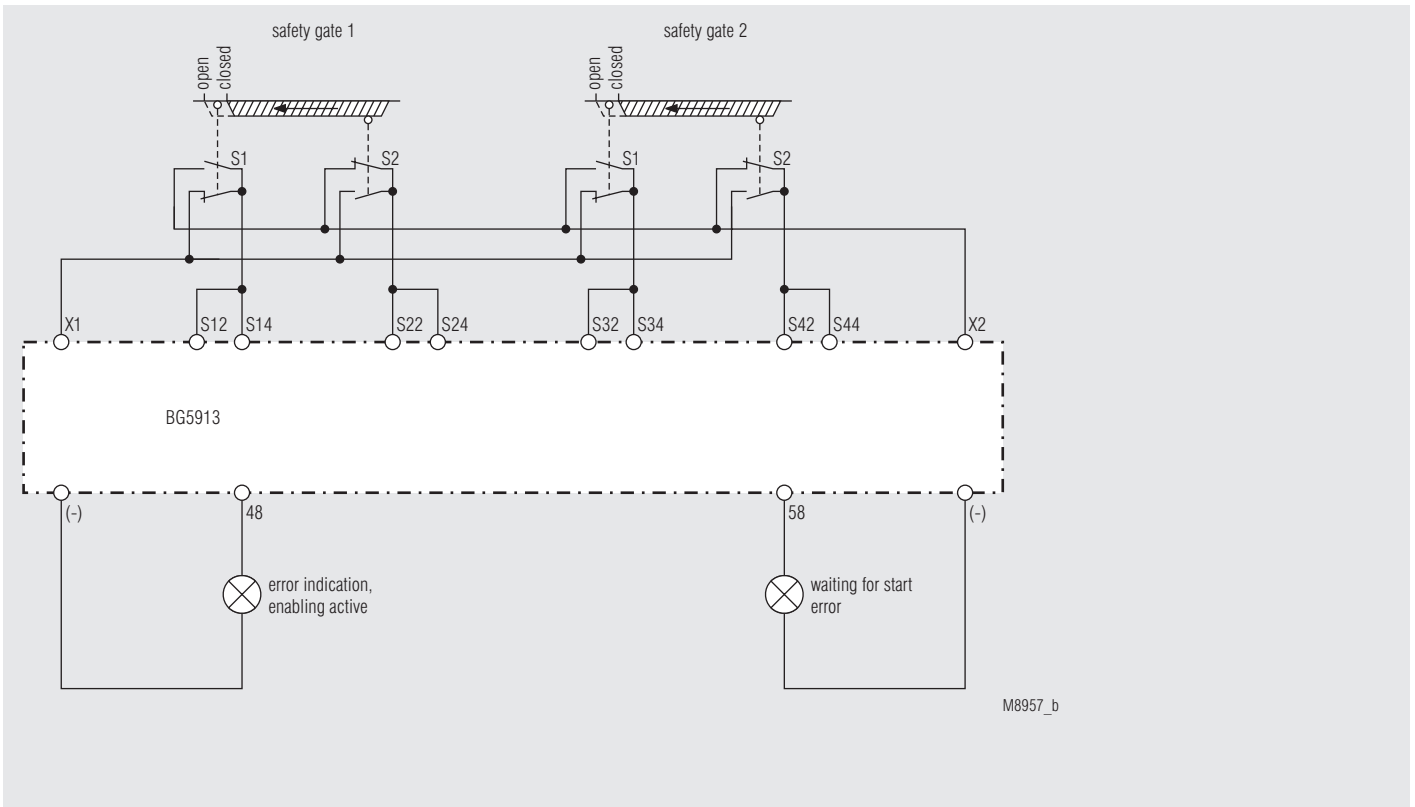

2 safety gates with 2 antivalent changeover contacts each; function: 5

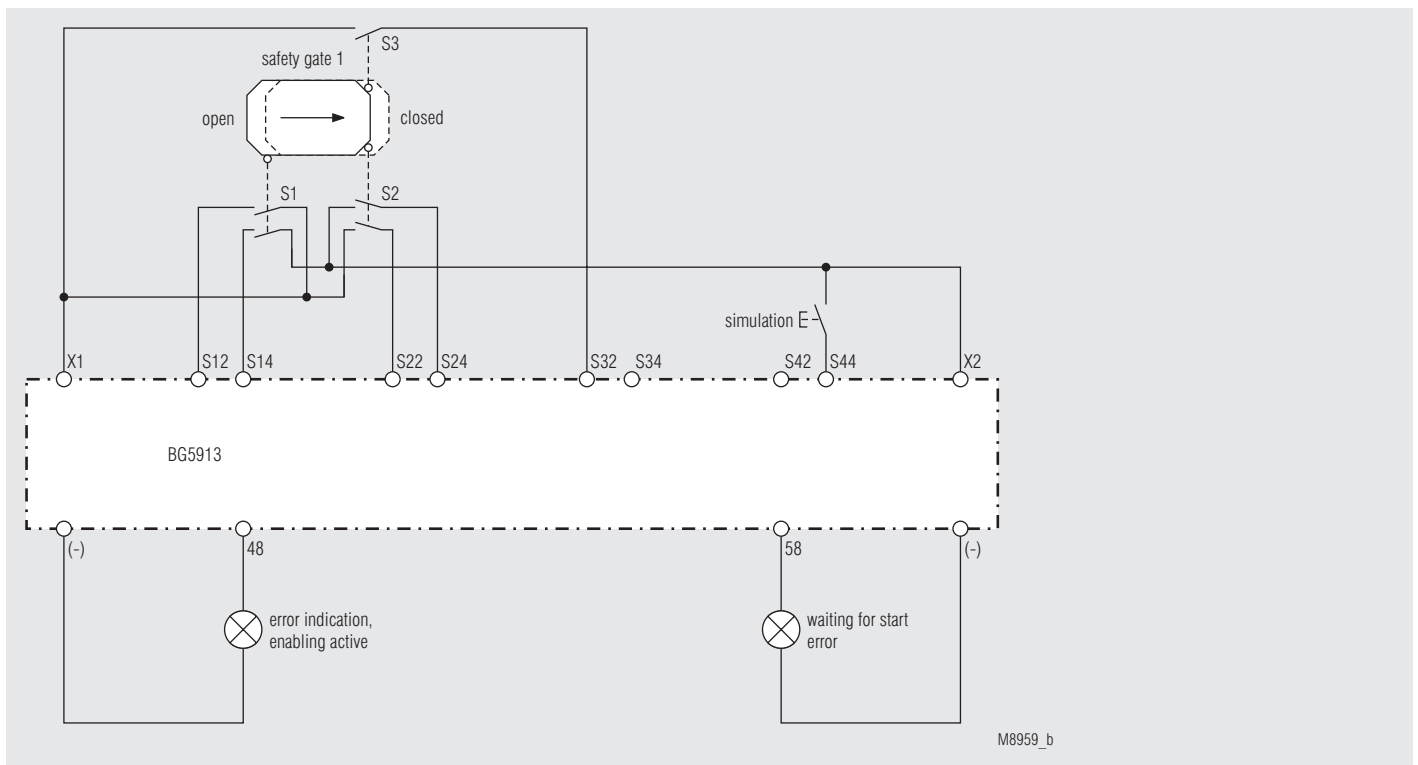

1 safety gate with 2 twin/1 single contact, manual start (plastic injection moulding machines); function: 6

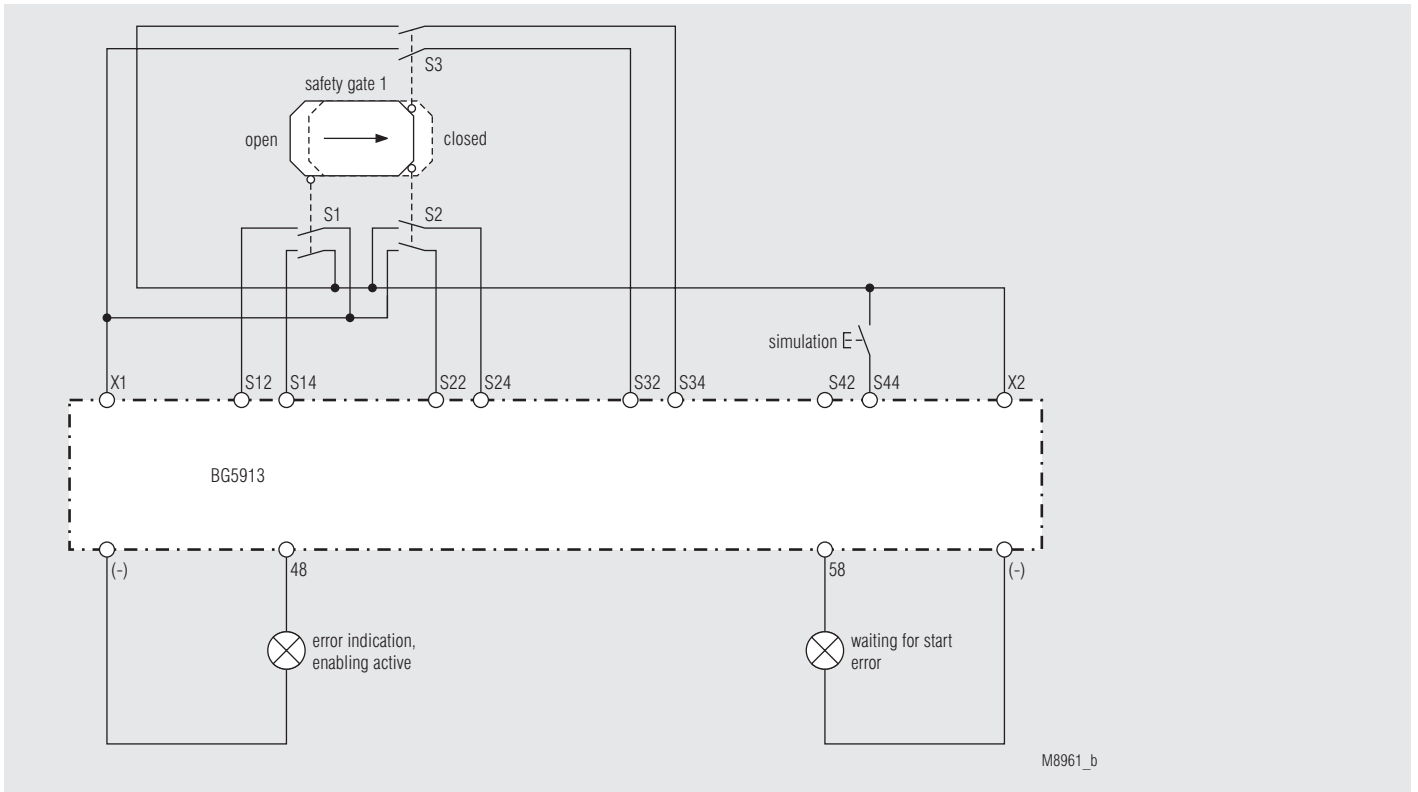

1 safety gate with 3 twin contacts, manual start (plastic injection moulding machines); function: 7

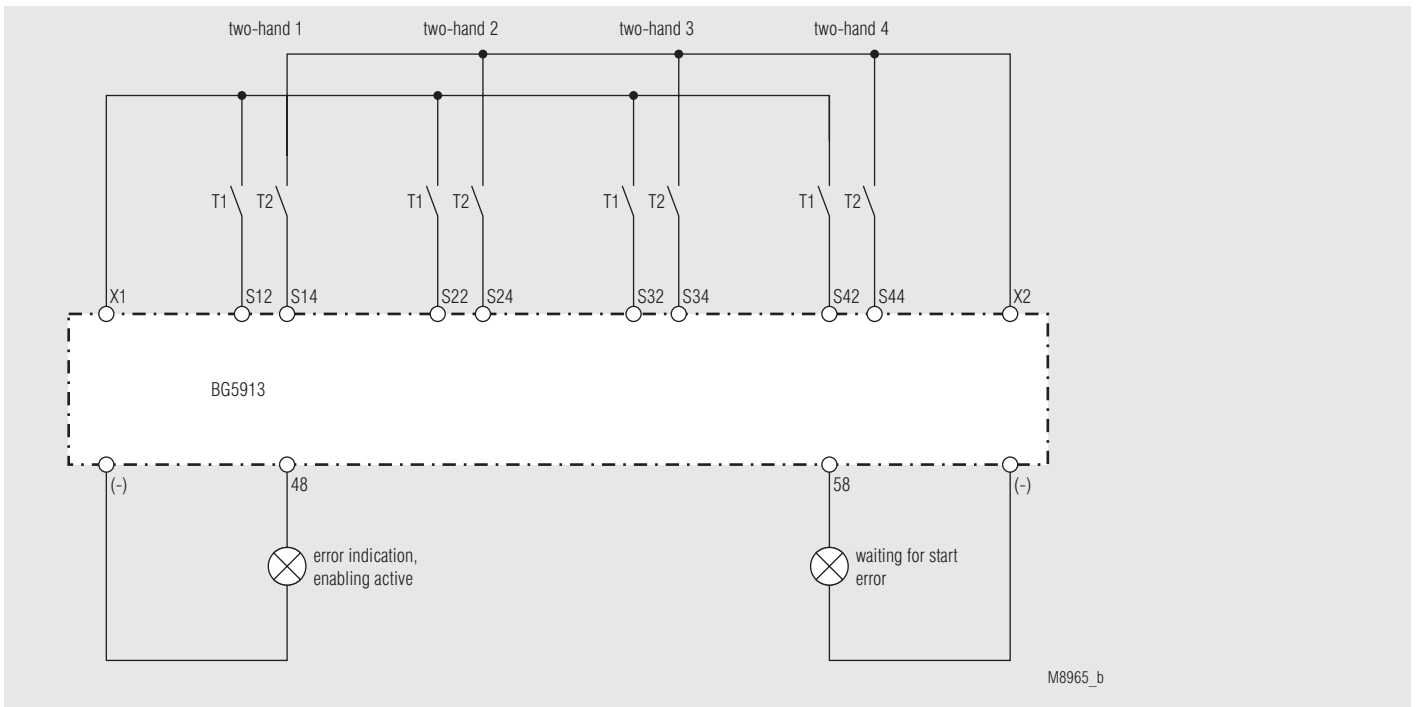

4 two-hand controls type IIIA acc. to DIN/EN 574; function: 8

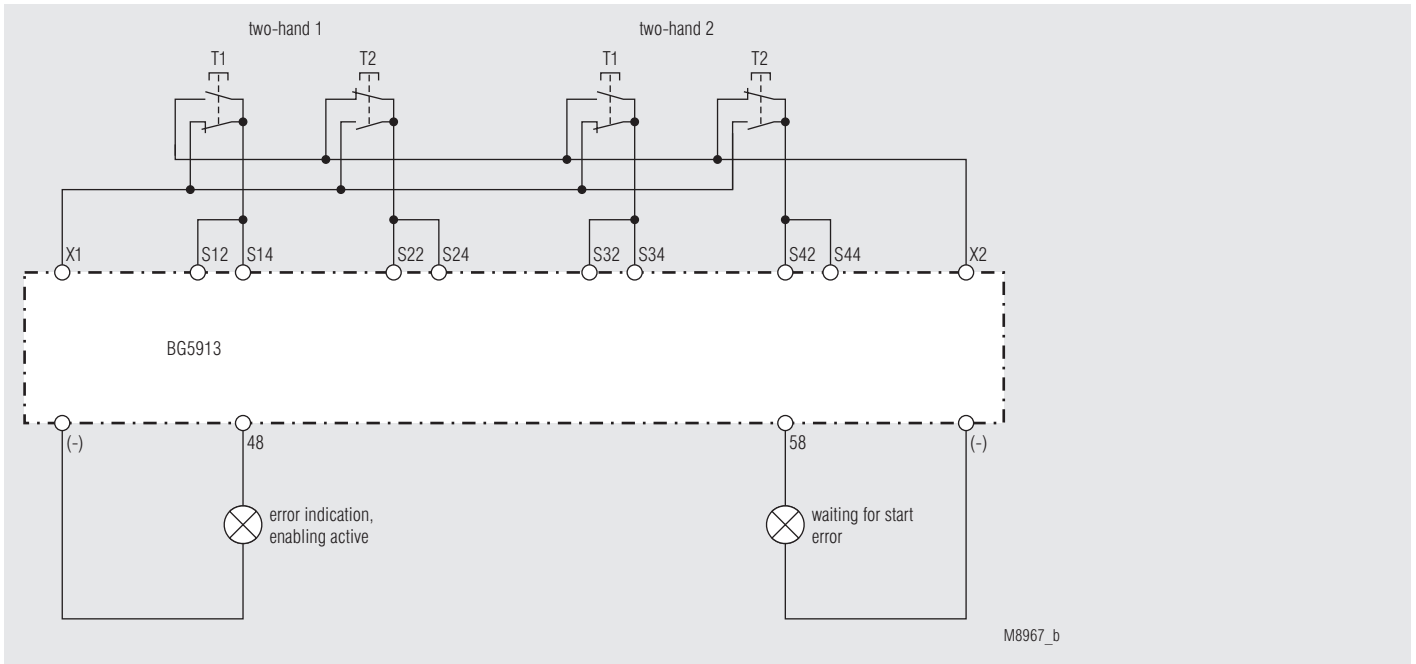

2 two-hand controls type IIIC acc. to DIN/EN 574; function: 9

**Technical Data**

**Voltage Supply**

**Nominal voltage  $U_N$ :** DC 24 V (coming from the basic module BH5911)

**Voltage range:** with max. 5% residual ripple: 0.85 ... 1.15  $U_N$

**Nominal consumption:** max. 60mA (no load on semiconductor outputs)

**Short-circuit protection of the modules:** internally with PTC

**Input**

**Control voltage** via X1, X2, 48, 58: DC 23 V at  $U_N$

**Control voltage** via S12, S14, S22, S24, S32, S34, S42, S44: 4.5 mA each at  $U_N$

**Minimum voltage** on S12, S14, S22, S24, S32, S34, S42, S44: DC 16 V

**Semiconductor Outputs**

Output at terminal 48 and 58: Transistor outputs, plus-connected  
 Output nominal voltage: DC 24 V, max. 100 mA constant current, max. 400 mA for 0.5 s  
 Internal short circuit, overtemperature, and overload protection

**Reaction Times** (time till reaction of the assigned output):

**Typ. NO time with  $U_N$ :**

Input modules BG 5913	Manual start	Automatic start	
		First start	Restart
Emergency stop	max. 80 ms	max. 1 s	max. 115 ms
Light barriers	max. 80 ms	max. 1 s	max. 115 ms
Safety gates	or simulation: max. 80 ms		Gate closing: max. 115 ms
Two-hand control	max. 85 ms		

**Technical Data**

**Break Time** (reaction time):

Input modules BG 5913	
Emergency stop	max. 33 ms
Light barriers	max. 33 ms
Safety gates	max. 33 ms
Two-hand control	max. 33 ms

**General Data**

**Operating mode:** Continuous operation  
**Temperature range:** ± 0 ... + 50 °C  
 At an operating temperature of 50 °C the modules must be mounted with a distance of 3 - 5 mm.

**Clearance and creepage distances**

rated impulse voltage / pollution degree: 4 kV / 2 (basis insulation) IEC 60 664-1  
**EMC:** IEC/EN 61 326-3-1, IEC/EN 62 061  
 Radio interference suppression: Limit value class A EN 55011

**Remark: This device is designed for industrial ambient conditions. When used in other environment, it is possible that wire bound or radiated interference occurs.**

**Degree of protection**

**Housing:** IP 20 IEC/EN 60 529  
**Terminals:** IP 20 IEC/EN 60 529

**Housing:** Thermoplastic with V0 behavior according to UL Subject 94

**Vibration resistance:** Amplitude 0.35 mm IEC/EN 60 068-2-6 Frequency 10...55 Hz,

**Shock resistance**

**Acceleration:** 10 g  
**Pulse duration:** 16 ms  
**Number of shocks:** 1000 per axis on three axes

**Climate resistance:** 0 / 050/ 04 IEC/EN 60 068-1

**Terminal designation:** EN 50 005

**Wire connection:** 1 x 2.5 mm<sup>2</sup> stranded wire with sleeve, or 1 x 4 mm<sup>2</sup> massive or 2 x 1.5 mm<sup>2</sup> stranded wire with sleeve  
 DIN 46 228-1/-2/-3/-4

**Wire fixing:** Box terminal with wire protection, removable terminal strips.

**Technical Data**

<b>Mounting:</b>	DIN rail	IEC/EN 60 715
<b>Weight:</b>		
BG 5913:	193 g	
BH 5913:	255 g	

**Standard Type**

BG 5913.08/00MF0	DC 24 V
Article number:	0055530
BH 5913.08/00MF0	DC 24 V
Article number:	0059242

**Dimensions****Width x height x depth**

BG 5913:	22.5 x 84 x 121 mm
BH 5913:	45 x 84 x 121 mm

**Safety Related Data for E-STOP****Values according to EN ISO 13849-1:**

Category:	4	
PL:	e	
MTTF <sub>d</sub> :	812.8	a
DC <sub>avg</sub> :	96.0	%
d <sub>op</sub> :	365	d/a (days/year)
h <sub>op</sub> :	24	h/d (hours/day)
t <sub>Zyklus</sub> :	3600	s/Zyklus
	≅ 1	/h (hour)

**Values according to IEC EN 62061 / IEC EN 61508:**

SIL CL:	3	IEC EN 62061
SIL	3	IEC EN 61508
HFT <sup>*)</sup> :	1	
DC <sub>avg</sub> :	96.0	%
SFF	99.2	%
PFH <sub>D</sub> :	2.34E-10	h <sup>-1</sup>

**Safety Related Data for light curtains ,safety gates or two-hand****Values according to EN ISO 13849-1:**

Category:	4	
PL:	e	
MTTF <sub>d</sub> :	2697.1	a
DC <sub>avg</sub> :	96.0	%
d <sub>op</sub> :	220	d/a (days/year)
h <sub>op</sub> :	12	h/d (hours/day)
t <sub>Zyklus</sub> :	138	s/Zyklus

**Values according to IEC/EN 62061 / IEC/EN 61508:**

SIL CL:	3	IEC/EN 62061
SIL	3	IEC/EN 61508
HFT <sup>*)</sup> :	1	
DC <sub>avg</sub> :	96.0	%
SFF	99.2	%
PFH <sub>D</sub> :	2.34E-10	h <sup>-1</sup>

<sup>\*)</sup> HFT = Hardware-Failure Tolerance



The values stated above are valid for the standard type.

Safety data for other variants are available on request.

The safety relevant data of the complete system has to be determined by the manufacturer of the system.